

## **ELECTRIC BUILT-IN OVENS**

WVE613, WVES613, WVE614, WVE615, WVEP615,  
WVE616, WVE617, WVEP617, WVEP618, WVE625,  
WVEP627, WVE636, WVE645, WVE655, WVE665

# CONGRATULATIONS

Dear customer,

Congratulations and thank you for choosing our oven.

We are sure you will find it a pleasure to use. Before you use the oven, we recommend that you read through the relevant sections of this manual, which provides a description of your appliance and its functions.

To avoid the risks that are always present when you use an appliance, it is important that the appliance is installed correctly and that you read the safety instructions carefully to avoid misuse and hazards.

We recommend that you keep this instruction booklet for future reference and pass it on to any future owners.

After unpacking the appliance, please check it is not damaged. If in doubt, do not use the appliance but contact your local customer care centre.

This appliance complies with requirements of Australian Standard AS/NZS 60335.2.6.

## Conditions of use

This appliance is intended to be used in household and similar applications such as:

- Staff kitchen areas in shops, offices and other working environments
- Farm houses
- By clients in hotels, motels and other residential type environments
- Bed and breakfast type environments

**Please ensure you read the instruction manual fully before you call for service, or a full service fee could be applicable.**

Record model and serial number here:

Model number:.....

Serial number:.....

PNC:.....

### IMPORTANT INFORMATION THAT MAY IMPACT YOUR MANUFACTURER'S WARRANTY

Adherence to the directions for use in this manual is extremely important for health and safety. Failure to strictly adhere to the requirements in this manual may result in personal injury, property damage and affect your ability to make a claim under the Westinghouse manufacturer's warranty provided with your product. Products must be used, installed and operated in accordance with this manual. You may not be able to claim on the Westinghouse manufacturer's warranty in the event that your product fault is due to failure to adhere to this manual.

# CONTENTS

- Important safety instructions.....3
- Installing your appliance.....5
- Product description .....10
- Before first use .....14
- Installing your oven accessories ..... 15
- Using your oven..... 17
- Cooking guide .....33
- Grilling guide .....34
- Steam assisted cooking .....35
- Dealing with cooking problems..... 37
- Getting to know the oven.....38
- Care and cleaning .....39
- Using your cooktop..... 50
- Troubleshooting..... 51
- Notes.....53
- Warranty..... 55

Please read the user manual carefully and store in a handy place for later reference.

The symbols you will see in this booklet have these meanings:



**WARNING**  
This symbol indicates information concerning your personal safety.



**CAUTION**  
This symbol indicates information on how to avoid damaging the appliance.



**IMPORTANT**  
This symbol indicates tips and information about use of the appliance.



**ENVIRONMENT**  
This symbol indicates tips and information about economical and ecological use of the appliance.

# IMPORTANT SAFETY INSTRUCTIONS

Please read the user manual carefully and store in a handy place for later reference.



## IMPORTANT

Important – check for any damages or marks.

- If you find the oven is damaged or marked, you must report it within 7 days if you wish to claim for damage/marks under the manufacturer's warranty. This does not affect your statutory rights.
- Discolouration of the enamel has no effect on the performance of the appliance.



## ENVIRONMENT

Information on disposal for users

- Most of the packing materials are recyclable. Please dispose of those materials through your local recycling depot or by placing them in appropriate collection containers.
- If you wish to discard this product, please contact your local authorities and ask for the correct method of disposal.



## WARNING

These warnings have been provided in the interest of safety. You **MUST** read them carefully before installing or using the appliance.

- An authorised person must install this appliance and carry out servicing. (Certificate of Compliance to be retained)
- Before using the appliance, ensure that all packing materials are removed from the appliance.
- Always be careful when you move the appliance because it is heavy. Always wear safety gloves.
- Do not pull the appliance by the door handle.
- This appliance must be earthed.
- In order to avoid any potential hazard, the enclosed installation instructions must be followed.
- Ensure that all specified vents, openings and air spaces are not blocked.
- Do not modify this appliance.
- This appliance must not be used as a space heater.
- Where the appliance is built into a cabinet, the cabinet material must be capable of withstanding 70°C. If adjacent to vinyl wrapped surfaces, use installation kit from vinyl wrap supplier.
- Ensure the appliance is switched off before cleaning or replacing parts. This can be done by switching off the appliance via the powerpoint or isolating switch (if available), or the switchboard.
- Do not use steam cleaners, as this may cause moisture build up.
- Switch the appliance off before removing the oven light glass for globe replacement.
- Do not open the oven door during steam cooking.
- Steam can be released. There is a risk of skin burns. There is a risk that steam causes moisture damage to cabinets.
- Allow the oven to cool down for 30 minutes before you drain the water tank in a steam oven. Scalding water may be released.
- Always keep the appliance clean. Ensure fats and oils do not accumulate around elements, burners or fans.
- Care must be taken when wiping exposed stainless steel edges....they can be sharp!
- Do not spray flammable materials in or under the appliance, e.g. aerosols.
- Do not leave the grill on unattended.
- Always turn the grill off immediately after use as fat left behind may catch fire.
- Do not cover the grill insert with foil, as fat left there may catch fire.
- Always keep the oven dish, grill dish and bake trays clean as any fat residue may catch fire.
- To avoid an accident, ensure that the oven shelves and fittings are always inserted into the appliance in accordance with the instructions.
- The door glass on this appliance is made from a tough, durable material that withstands heating and cooling without breaking. As a precaution however, do not put cold water on hot glass.
- Door glass that is damaged should be immediately replaced.
- This appliance is not intended for use by persons (including children) with reduced physical, sensory or mental capabilities, or lack of experience and knowledge, unless they have been given supervision or instruction concerning use of the appliance by a person responsible for their safety.
- Children should be supervised to ensure that they do not play with the appliance.
- Accessible parts will become hot when in use. To avoid burns and scalds, children should be kept away.
- During use, this appliance becomes hot. Care should be taken to avoid touching hot surfaces, e.g. oven door, heating elements or internal surfaces of the oven.
- Always use gloves when handling hot items inside the oven.
- To maintain safe operation, it is recommended that the product be inspected every 5 years by an authorised service person.
- New appliances can have an odour during the first operation. It is recommended to 'run in' the oven before you cook. Run the oven(s) at 180°C for 30 minutes and ensure the room is well ventilated.
- This appliance must not be installed behind a decorative door.
- The cooking process has to be supervised. A short term cooking process has to be supervised continuously.

## IMPORTANT SAFETY INSTRUCTIONS

### Cooktop only

- If the ceramic glass on cooktop is accidentally cracked, switch off the appliance to avoid the possibility of electric shock.
- Unattended cooking on a hob with fat or oil can be dangerous and may result in a fire.



### CAUTION

Read the following carefully to avoid damage to the appliance.

- The grill door must be left fully open whilst grilling in a separate grill wall oven and a separate grill underbench oven.
- The grill tray must be fully inserted whilst grilling.
- Do not place thick portions of food under the grill. Foods may curl, catch and ignite.
- Do not use the door as a shelf.
- Do not push down on the open oven door.
- Do not use harsh abrasive cleaners or metal scrapers to clean the oven door glass since they can scratch the surface which may result in shattering of the glass.
- Do not use harsh abrasive cleaners, powder cleaners, steel wool or wax polishes on enamel.
- Do not use sharp metal implements or utensils on any surface, as these may leave permanent scratches or marks.
- Do not use stainless steel cleaners, abrasive cleaners or harsh solvents to clean your stainless steel appliance.
- Do not line the bottom of the oven or grill with foil or cookware, it will damage the enamel.
- Do not use the base of the oven for cooking – it will damage the enamel.
- Do not put water directly into the hot appliance.
- Always clean the appliance immediately after any food spills.

### Cooktop only

- Do not allow pots to boil dry as damage to both pan and cooktop may result.
- Do not operate the cooktop for an extended period of time without a utensil on the hot plate.
- Do not allow large cookware to overhang onto the adjacent benchtop. This will cause scorching to the benchtop surface.
- Do not place heat resistant mats, wire mats or aluminium foil under pots or pans.
- Do not cook food directly on the ceramic glass surface.
- Do not use round bottom woks, wok stands or similar utensils that could lead to overheating of hotplates and possible damage to the cooking surface.
- Do not operate this appliance by means of an external timer or separate remote control system.
- Danger of fire: Do not store items on cooking surfaces.

*NOTE: You must read these warnings carefully before installing or using the appliance. If you need assistance, contact your Customer Care Centre. The manufacturer will not accept liability, should these instructions or any other safety instructions incorporated in this book be ignored.*

## INSTALLING YOUR APPLIANCE

### WARNING

To avoid any potential hazard, you must follow our instructions when you install your appliance. Failure to install the appliance correctly could invalidate any warranty or liability claims and lead to prosecution.

- This appliance must be installed by an authorised person according to all codes and regulations as stated in the local municipal building code and other relevant statutory regulations.
- Wiring connections must be in accordance with AS/NZS 3000 Wiring Rules and any particular conditions of the local authority.
- Refer to data plate for rating information. The data plate is positioned behind the bottom of the oven door.
- Disconnection in the fixed wiring must occur in accordance with the AS/NZS3000 wiring rules.
- Wiring should be protected against mechanical failure. Refer to AS/NZS3000 clauses 3.3.2.6, 3.9, 3.10
- A means of disconnection with a contact separation of at least 3mm must be supplied in the fixed wiring.
- This range must be connected with cable of 75°C rating minimum.
- This product has passed the insulation resistance test after manufacture. If the resistance reading is low at installation, it is probably caused by moisture from the atmosphere being absorbed by the elements after the range has been produced. (Pass at 0.01MΩ AS/NZS 3000 Wiring Rules Clause 8.3.6.2).

### Rated power input

MODEL	TOTAL kW	A1 kW	A2 kW
WVE645	8.7	2.3	6.4

MODEL	PRODUCT DIMENSIONS (H X W X D) MM	MIN FUSE RATING	MAX POWER RATING	MAX CURRENT RATING	WIRE SECTION (MM <sup>2</sup> )
WVE613	597 x 596 x 569	16A	2.3kW	9.6A	2.5
WVES613	597 x 596 x 569	16A	2.3kW	9.6A	2.5
WVE614	597 x 596 x 569	16A	2.3kW	9.6A	2.5
WVE615	597 x 596 x 569	16A	3.3kW	13.8A	2.5
WVE615SCA/DSCA	597 x 596 x 569	16A	3.1kW	12.9A	2.5
WVE616	597 x 596 x 569	16A	3.0kW	12.7A	2.5
WVEP615	597 x 596 x 573	16A	3.1kW	12.9A	2.5
WVE617	597 x 596 x 569	16A	3.3kW	13.8A	2.5
WVEP617	597 x 596 x 573	16A	3.3kW	13.8A	2.5
WVEP618	597 x 596 x 573	16A	3.1kW	12.9A	2.5
WVE625	890 x 596 x 569	25A	5.3kW	22.1A	4.0
WVE636	1083 x 596 x 569	32A	6.2kW	25.8A	6.0
WVE645	597 x 596 x 569	40A	8.7kW	36.1A	6.0
WVE655	727 x 596 x 569	25A	4.9kW	20.4A	4.0
WVE665	890 x 596 x 569	25A	5.3kW	22.1A	4.0
WVEP627	890 x 596 x 573	25A	5.3kW	22.1A	4.0

Note: Electrical connection is 230-240 volts AC 50Hz. Wiring minimum temperature rating 75°C.

### WARNING

This appliance must be properly earthed.

- Do not lift the appliance by the door handles.
- Prepare the cupboard opening to match your appliance measurements. (See diagrams)
- Slide appliance into the cupboard, ensuring that the supply cable (where fitted) does not kink.
- To prevent tipping, use the screws supplied to secure your oven into the cupboard. Use just 2 screws for underbench and separate grill underbench ovens, and 4 screws for separate grill wall ovens. Remove the bottom door in separate grill wall ovens to provide access to the bottom 2 screwing points.
- For appliances fitted with a flexible supply cord, if the cord is damaged, it must be replaced by the manufacturer or its service agent or similarly qualified person in order to avoid a hazard. The plug must be accessible after installation.
- Where the appliance is built into a cabinet, the cabinet material must be capable of withstanding 70°C. Installation into low temperature tolerant cabinetry (e.g. vinyl coated) may result in deterioration of the low temperature coating by discolouring or bubbling.
- If the appliance is installed adjacent to vinyl-wrapped surfaces, use an installation kit available from the vinyl-wrap supplier.
- Electrolux Home Products cannot accept responsibility for damage caused by installation into low temperature tolerant cabinets.
- After installation, test and ensure that the appliance operates correctly before handing it over to the customer. It is recommended that this product is not installed in an unvented living space, particularly if that space incorporates sleeping quarters.

## INSTALLING YOUR APPLIANCE (CONTINUED)

- If a powerpoint is fitted it must be accessible with the appliance installed, as the plug must be accessible after installation.
- This appliance must be mounted on a flat surface for the full width and depth of the product.
- To avoid overheating, the appliance must not be installed in a recess or cupboard behind a decorative door.

### Hard wiring detail

1. Remove terminal cover plate from rear panel of appliance.
2. Fit wires through hole in cover plate and make connections to terminals.
3. Engage wires into plastic clip. Secure plastic clip with two long silver screws (supplied in separate bag).
4. Replace cover plate onto rear panel.

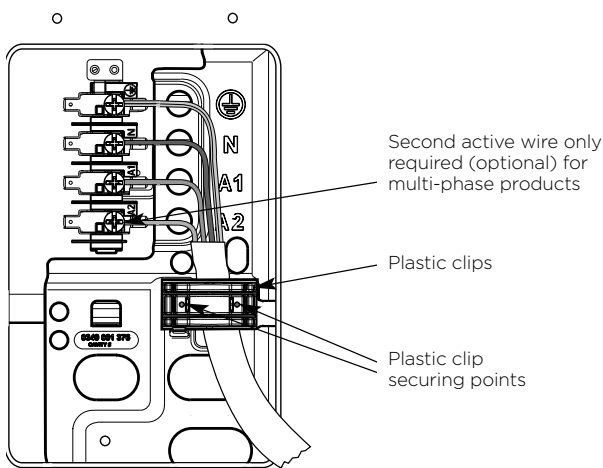
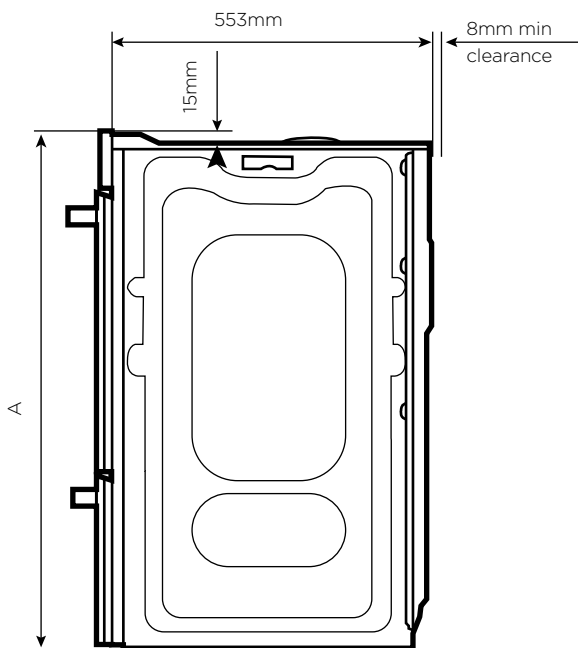

### Cabinet construction for your appliance

For the best integration within a kitchen, install the appliance in a standard 600mm wide cupboard that gives a flush fit with the surrounding cupboard fronts as shown in Fig. A. A recess of 20 mm is ideal.

With the exception of pyrolytic ovens, the appliance can also be installed using a proud fit to the surrounding cupboard as shown in Fig. B.

### ⚠ CAUTION

For all Pyrolytic clean oven models, the oven must be installed as a flush fit to the surrounding cupboards and the "Infill panel" MUST not exceed 100mm in length. This ensures a 16mm gap is maintained between the cabinet and oven side to prevent the cupboard overheating.

Fig. A

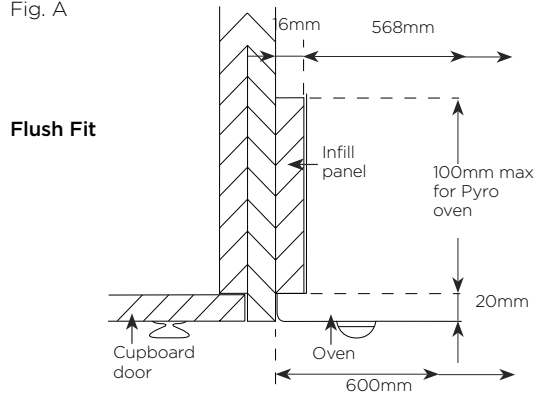
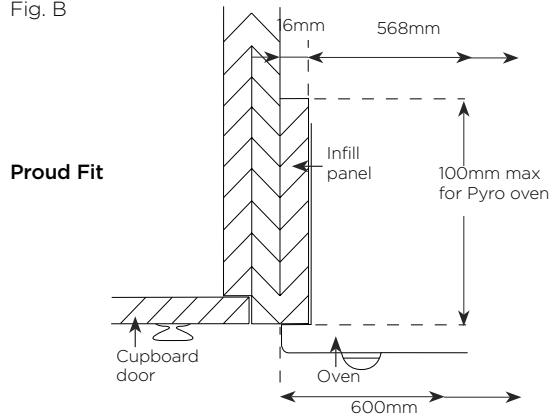
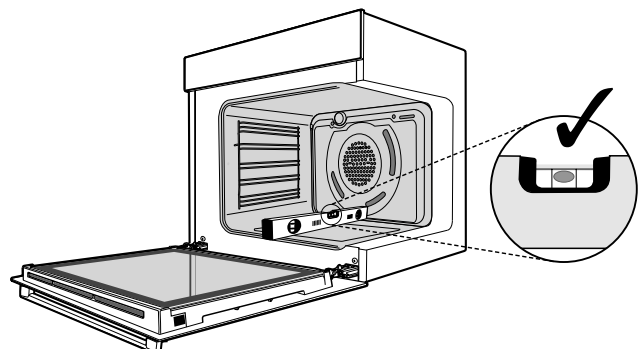

Fig. B



### Levelling oven

Place a level in the oven as below, making sure the level sits on the front and rear forms.



### Non-pyrolytic underbench ovens and side open door oven

Your underbench oven looks best when the control panel is directly under the benchtop. An upper infill panel may have to be added if the cooktop placed over the oven is too deep. Refer to cooktop installation instructions for required clearance between cooktop and oven.

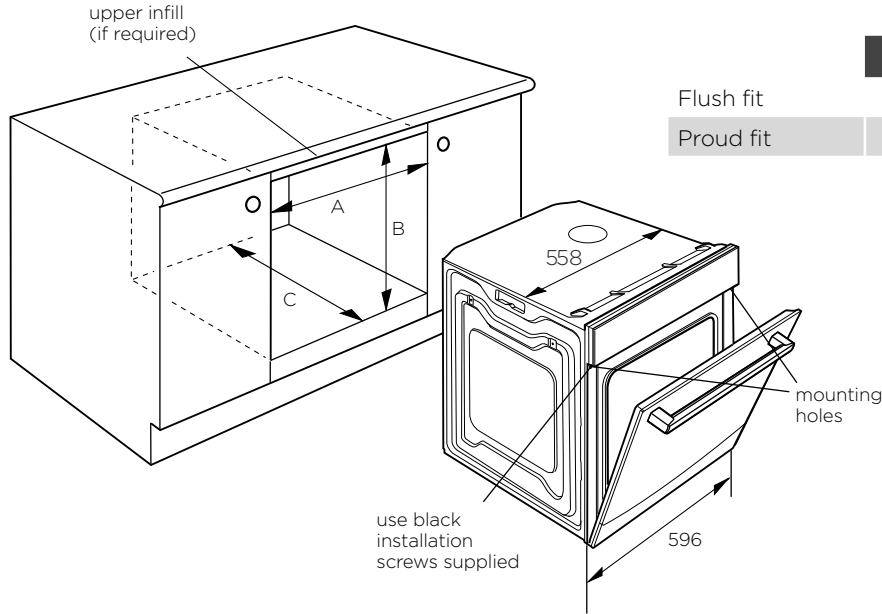

	A	B	C
Flush fit	600	600	581min
Proud fit	565	590	560min

### Pyrolytic underbench oven

Your underbench oven looks best when the control panel is directly under the benchtop. An upper infill panel may have to be added if the cooktop placed over the oven is too deep. Refer to cooktop installation instructions for required clearance between cooktop and oven.

Power point connection for the WVEP618 must be accessible with the appliance fully installed. If the supply cord is damaged it must be replaced by the manufacturer, its service agent or similarly qualified persons in order to avoid a hazard.



#### CAUTION

NOTE: Dimension "D".

A requirement for all pyrolytic clean ovens – for proper ventilation there must be a gap at the bottom rear of the cabinet. This can be a full width opening 20mm deep.

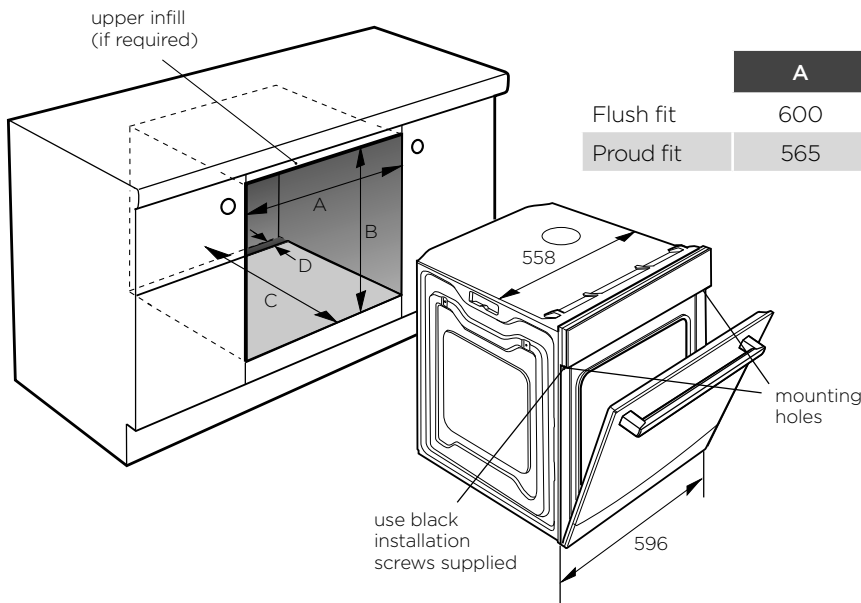

	A	B	C	D
Flush fit	600	600	581min	20
Proud fit	565	590	560min	20

## INSTALLING YOUR APPLIANCE (CONTINUED)

### Separate grill underbench oven

Your underbench oven looks best when the control panel is directly under the benchtop. An upper infill panel may have to be added if the cooktop placed over the oven is too deep. Refer to cooktop installation instructions for required clearance between cooktop and oven.

*NOTE TO INSTALLER: For separate grill underbench installations where a cooktop is installed directly above the appliance, a minimum clearance distance of 10mm must be allowed for between the bottom of the cooktop & the top of the separate grill underbench oven.*

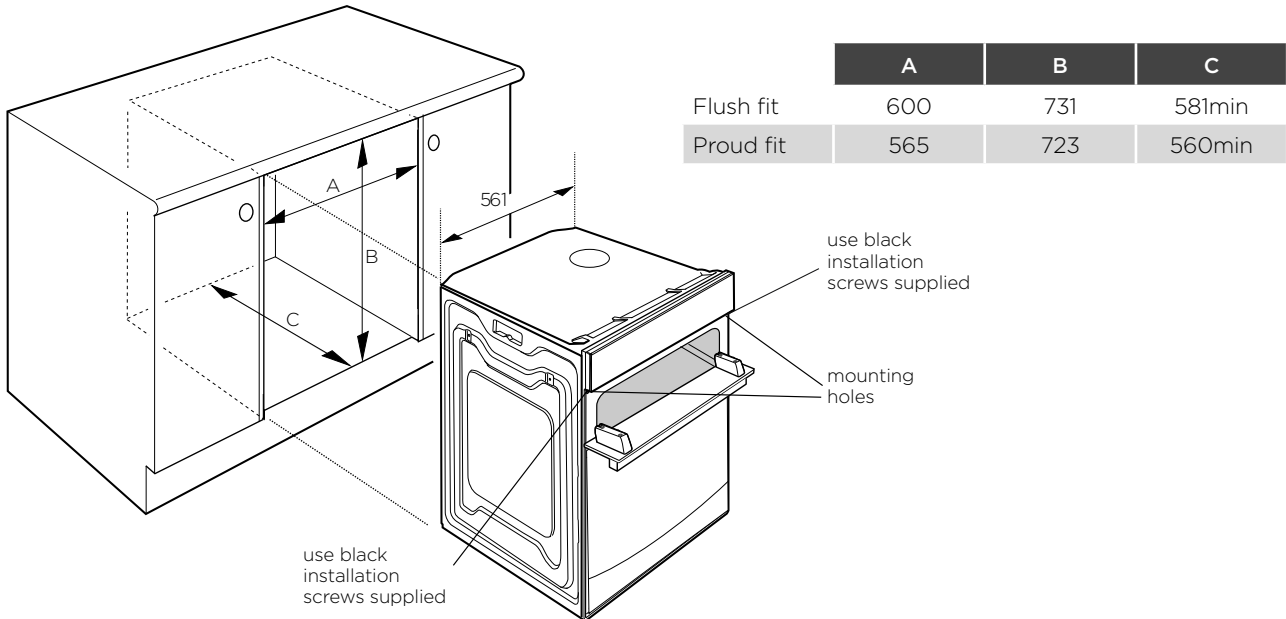

### Separate grill wall oven & duo oven



#### CAUTION

*NOTE: Dimension "D".*

*A requirement for all separate grill wall ovens and all duo ovens – for proper ventilation there must be a gap at the bottom rear of the cabinet. This can be a full width opening 20mm deep.*

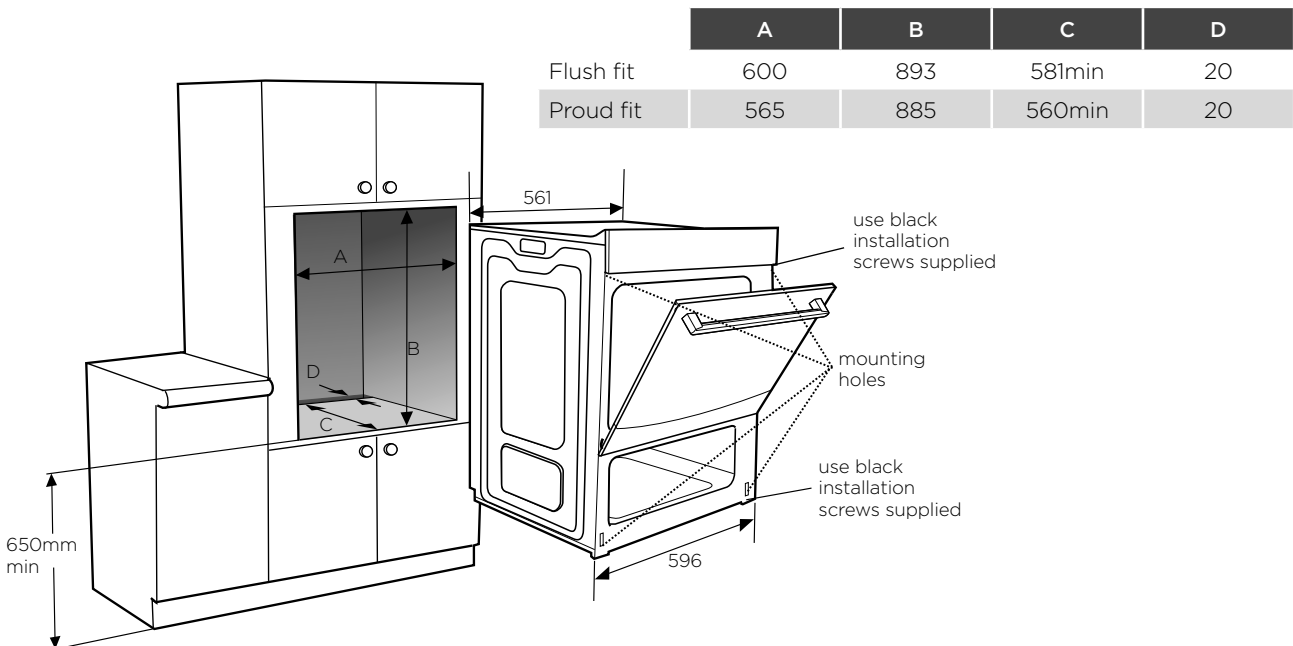



## Double oven

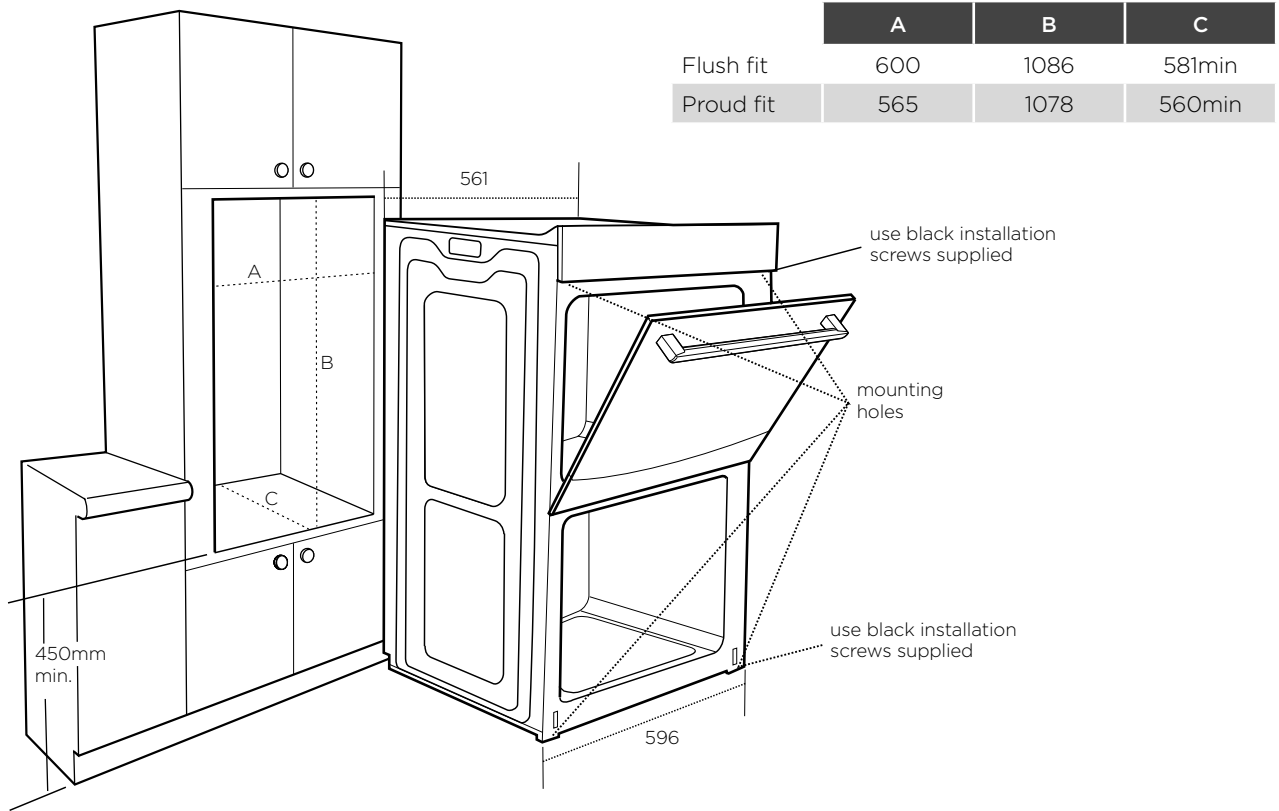

## Combo oven - cooktop cut-out dimensions

A minimum gap of 40mm must be maintained between the top of the underbench oven and the bottom of the cooktop to ensure adequate ventilation and space for the interconnection lead.

The cooktop must be installed above the underbench oven.

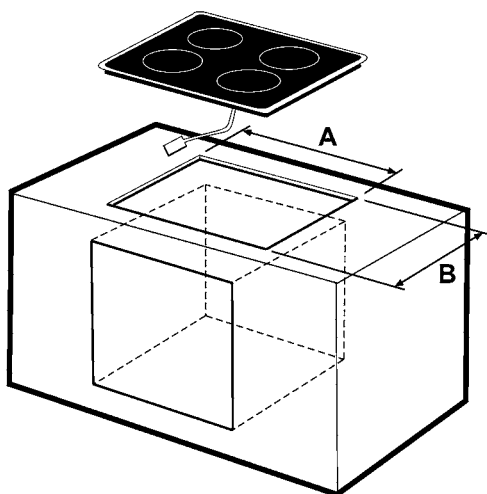

### COOKTOP DIMENSIONS

Overall Cooktop Dimensions

Width	610mm
Depth	515mm
Depth of base	45mm

### COOKTOP CUT-OUT DIMENSIONS

	A	B
Cooktop	560mm	490mm

A minimum gap of 40mm must be maintained between the top of the underbench oven and the bottom of the cooktop to ensure adequate ventilation and space for the interconnection lead.



### CAUTION

The cooktop **MUST** be installed above the underbench oven.

# PRODUCT DESCRIPTION

## WVE613/WVES613/WVES614

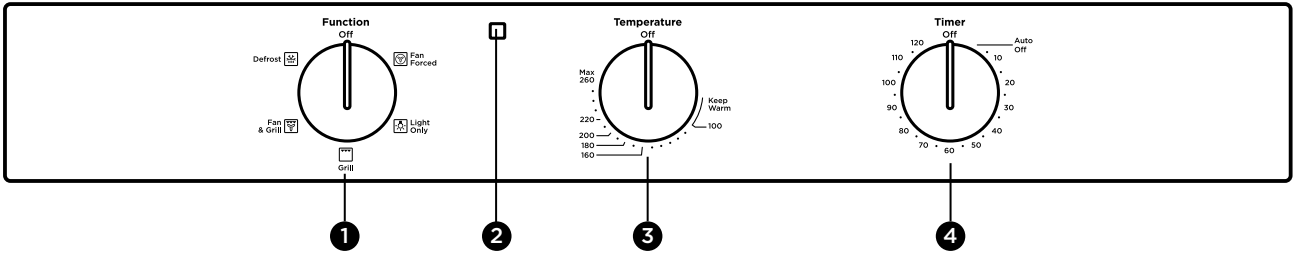

## WVE615

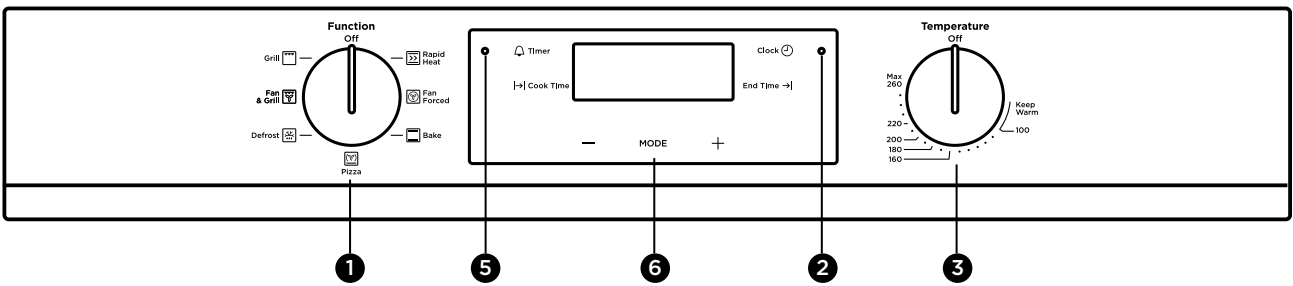

## WVEP615

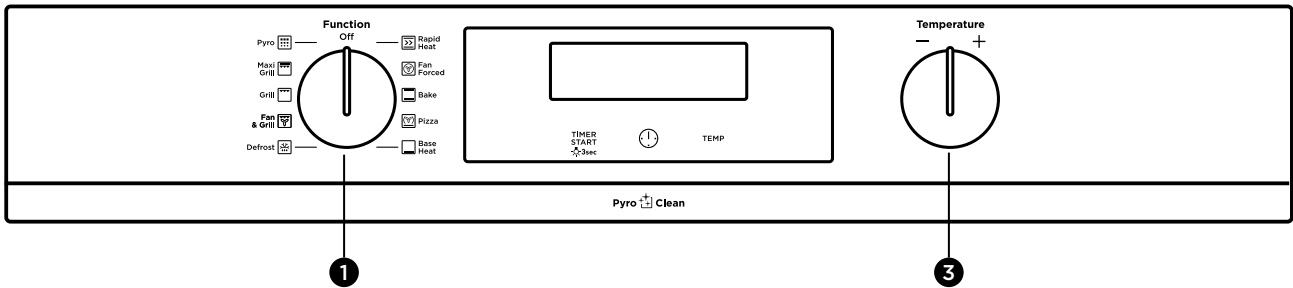

- 1 Function selector
- 2 Oven/grill indicator light
- 3 Oven/grill temperature selector
- 4 'Auto-off' timer
- 5 Function indicator light
- 6 Electronic Clock

**WVE616**

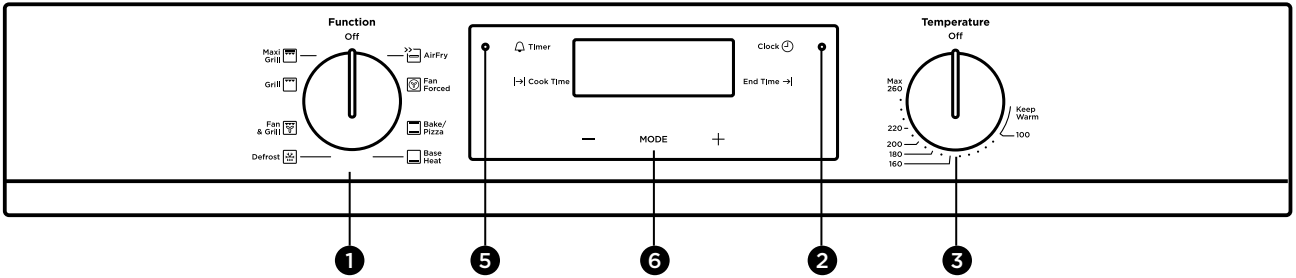

**WVE617**

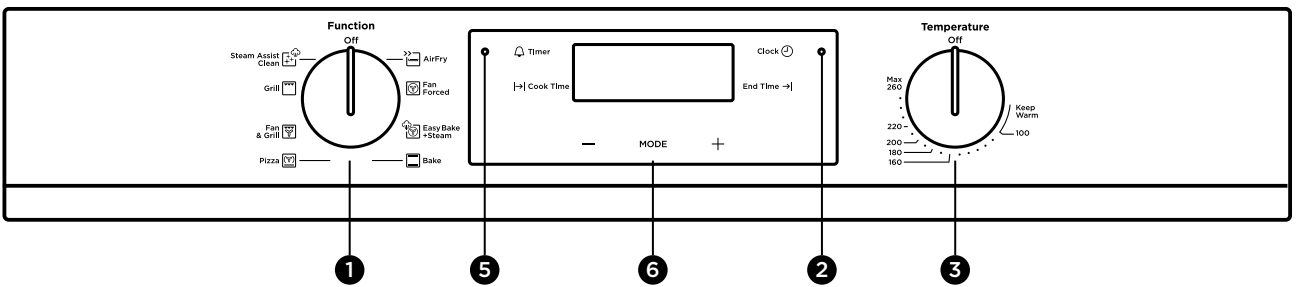

**WVEP617**

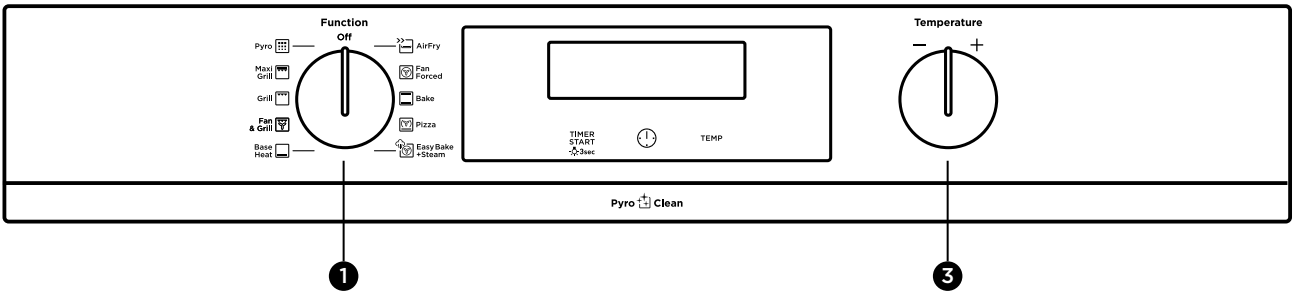

**WVEP618**

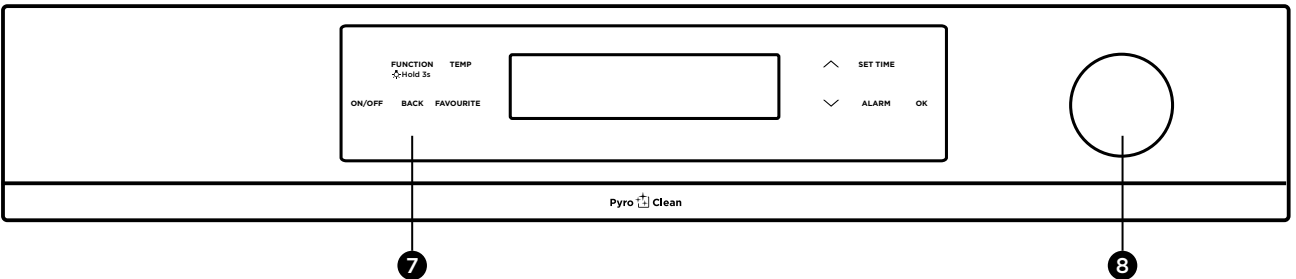

- 1 Function selector
- 2 Over/grill indicator light
- 3 Over/grill temperature selector
- 4 'Auto-off' timer
- 5 Function indicator light
- 6 Electronic Clock
- 7 Programmable controller
- 8 Water drawer

# PRODUCT DESCRIPTION (CONTINUED)

## WVE615SCA/DSCA

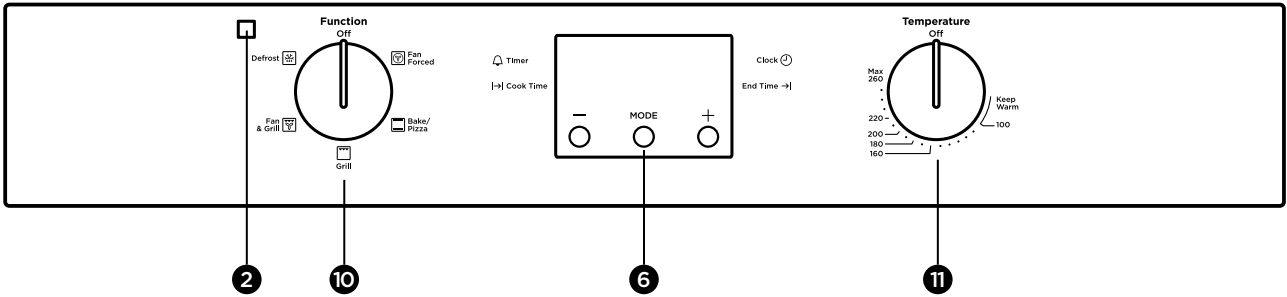

## WVE625

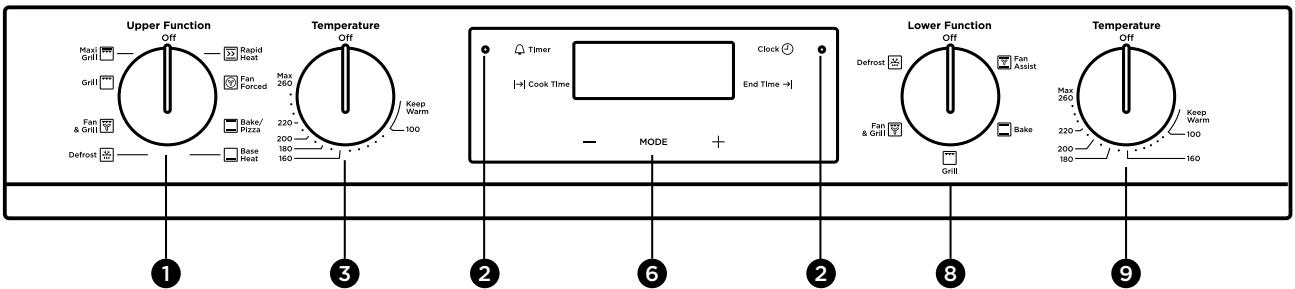

## WVEP627

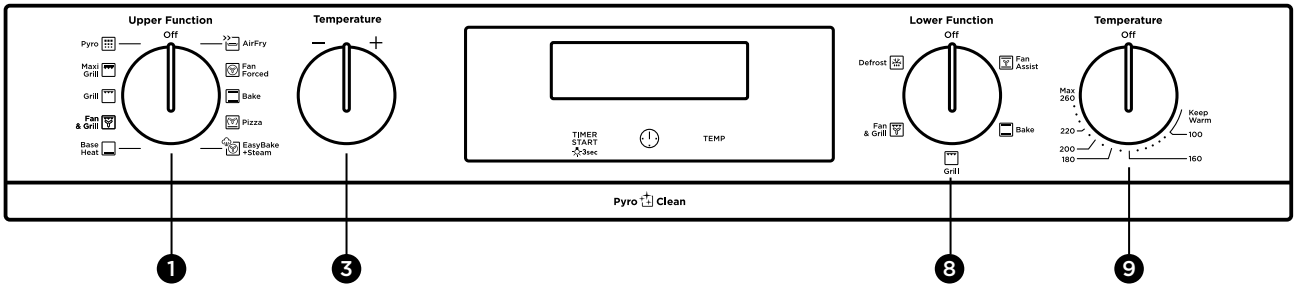

## WVE636

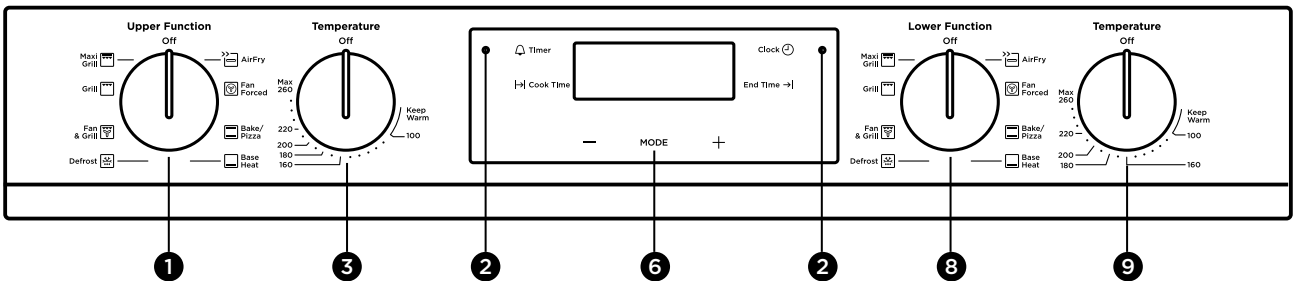

- |   |                            |   |
|---|----------------------------|---|
| 1 Upper function selector               | 5 Function indicator light | 9 Lower oven/grill temperature selector |
| 2 Oven/grill indicator light            | 6 Electronic Clock         | 10 Function selector                    |
| 3 Upper oven/grill temperature selector | 7 Programmable controller  | 11 Temperature selector                 |
| 4 'Auto-off' timer                      | 8 Lower function selector  |   |

## WVE645

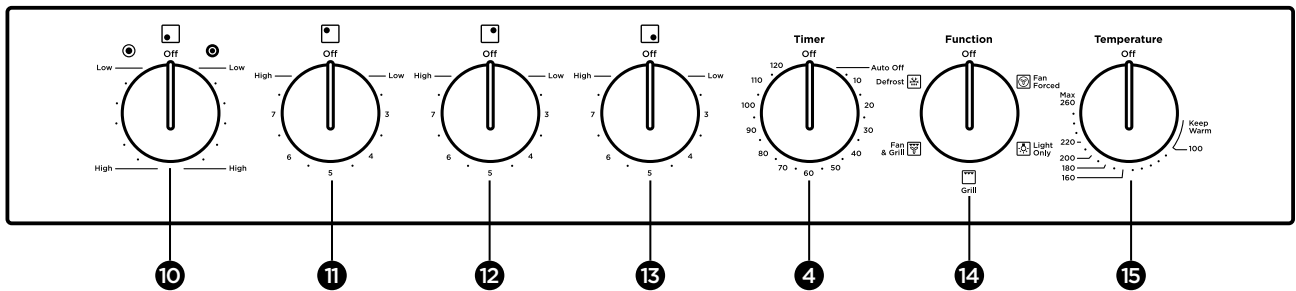

## WVE655

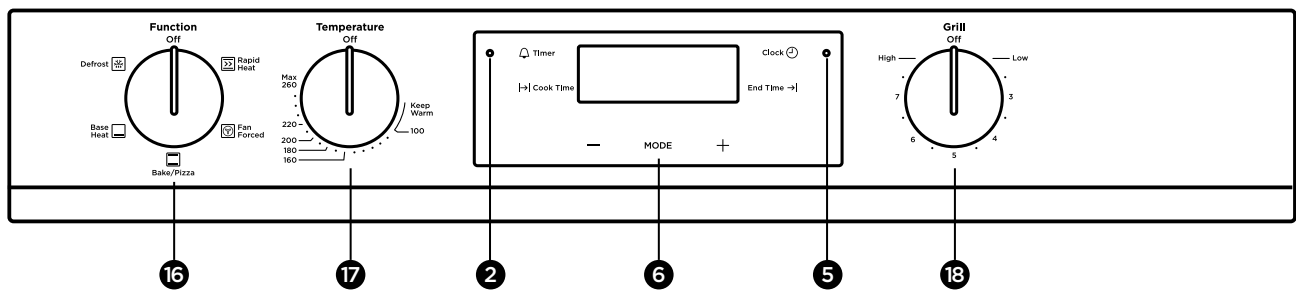

## WVE665

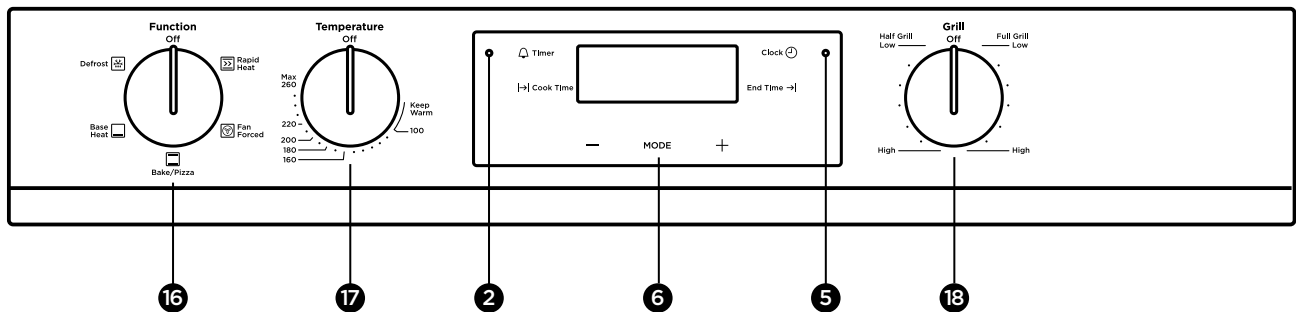

- |  |  |   |
|--|--|---|
| <b>1</b> Upper function selector               | <b>8</b> Lower function selector                           | <b>14</b> Oven/grill function selector        |
| <b>2</b> Oven/grill indicator light            | <b>9</b> Lower oven/grill temperature selector             | <b>15</b> Oven/grill temperature selector     |
| <b>3</b> Upper oven/grill temperature selector | <b>10</b> Bottom left hob full and half on/off/temperature | <b>16</b> Oven function selector              |
| <b>4</b> 'Auto-off' timer                      | <b>11</b> Top left hob on/off/temperature                  | <b>17</b> Oven temperature selector           |
| <b>5</b> Grill indicator light                 | <b>12</b> Top right hob on/off/temperature                 | <b>18</b> Grill function/temperature selector |
| <b>6</b> Electronic Clock                      | <b>13</b> Bottom right hob on/off/temperature              |   |
| <b>7</b> Programmable controller               |  |   |

## BEFORE FIRST USE

### Preparing your appliance for the first time

- Please remove all internal boxes and bags from the oven before operation.
- Please wipe out the oven interior prior to operation with warm soapy water and polish dry with a soft clean cloth. Do not close the oven door until the oven is completely dry.
- If your appliance is fitted with a mechanical "Auto Off" timer, make sure it is set to "Off" marker for manual operation.

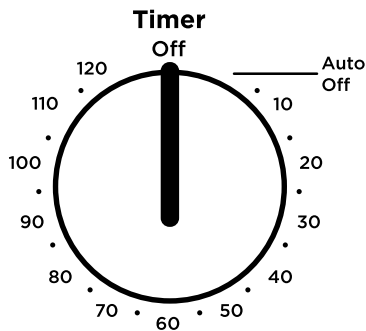



### CAUTION

- Do not line the oven with foil as it will damage the enamel.
- New appliances can have an odour during first use. It is recommended to 'run in' the oven before cooking for the first time. Operate the oven(s), empty, at a temperature of 180°C for approximately 30 minutes. For appliances with a separate grill, run the grill on maximum for 15 minutes WITH GRILL DOOR OPEN. Please ensure that the room is well ventilated during this process.

### Setting the time of day

If you have purchased a model fitted with an electronic clock or programmable controller, you must set the time of day before you can operate your appliance.

#### Electronic clock

- After the appliance has been electrically connected, "12.00" will be displayed and the "Clock" indicator symbol  will flash.
- To set the time of day, press the **-** or **+** symbols.
- After 5 seconds from the last change, the "Clock" indicator symbol  will disappear, confirming the time has been set.

*NOTE: The clock has a 24 hour display.*

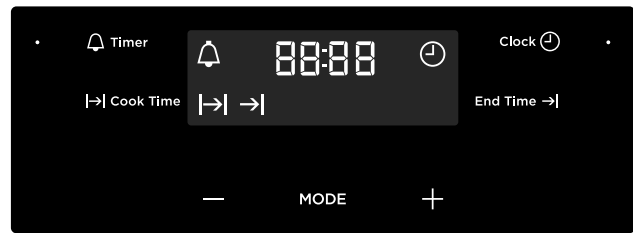

### WVEP615, WVEP627, WVEP617 controller

Before the appliance can be used, the time must be set.

When power is supplied to the oven, the clock icon will be displayed. Along with the  clock symbol the "12" will be flashing. This indicated that the "hour" portion of the time is ready to be changed.



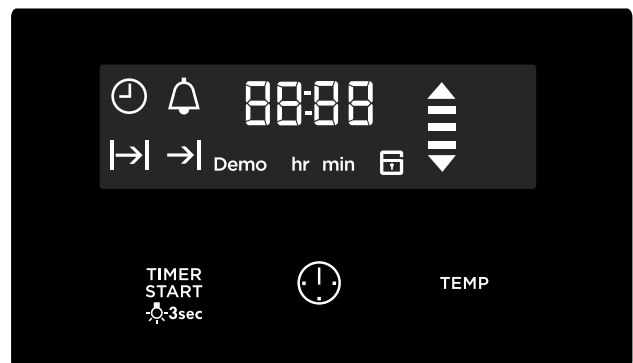

Toggle the temperature selector **-** or **+**, then touch  when you have the right hour.

The minutes will flash and can be set in the same manner. 5 seconds after the last change, the clock display will stop flashing, confirming that the time has been set.

*NOTE: The clock has a 24 hour display.*



### WVEP618 programmable controller

- After the appliance has been electrically connected, press **ON/OFF** to turn ON
- To set the time, press  until "Settings" is highlighted and press **OK**
- Then, "Set time of day" is highlighted and press **OK**
- Press  or  to set the hour and press **OK**
- Press  or  to set the minutes and press **OK**
- Press **BACK** to return to function menu



# INSTALLING YOUR OVEN ACCESSORIES

## Slides (Telescopic runners)

1. Obtain left hand side rack and left hand slide – see image to identify.

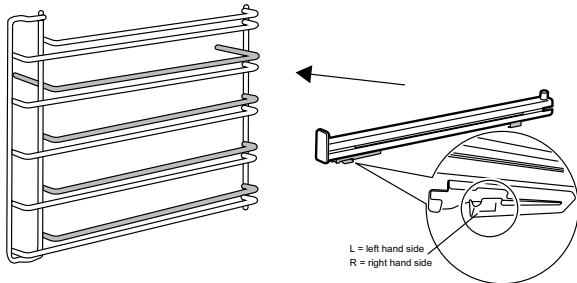

2. The shaded wires indicate the wire the slide can be mounted on. Fit slide rear clips to the rear of wire at an angle as shown below.

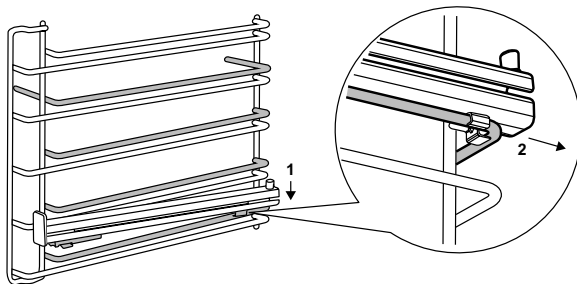

3. Push slide front clip over wire until secured

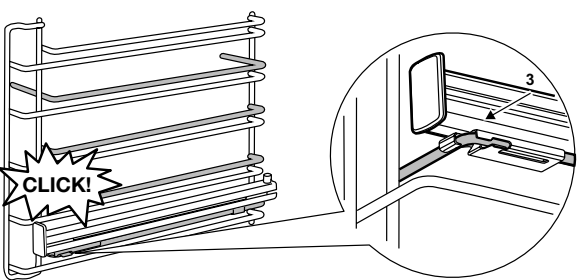

## Side racks

- The side racks attach to each side of your oven. There is a left hand and right hand version (see image below for details).
- Insert the rear peg into the rear access hole provided, ensuring that the peg is fully inserted.
- Then locate the front peg into the front access hole and push in firmly.
- For the grill compartments on WVE626, WVE665, and WVEP627 models, the side rack fitment is the same as above.

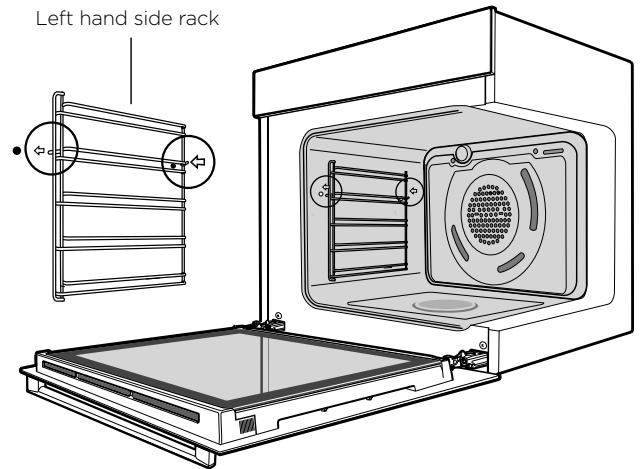

## Shelves and trays

The shelves are designed so that they have maximum extension but cannot be accidentally pulled right out.

To fit a shelf to side racks:

*NOTE: To Locate the rear edge of the shelves, the detents on the side wires should be towards the oven back wall. See image.*

1. Rest the rear edge of the shelf on the lower guide rail of the side rack - see diagram. Ensure the same rail positions on both sides of the oven are being engaged.
2. With the front edge raised, begin to slide the shelf in between the guide rails of the side rack.
3. Once the detents have passed the front edge of the side rack, the shelf can be pushed fully in.

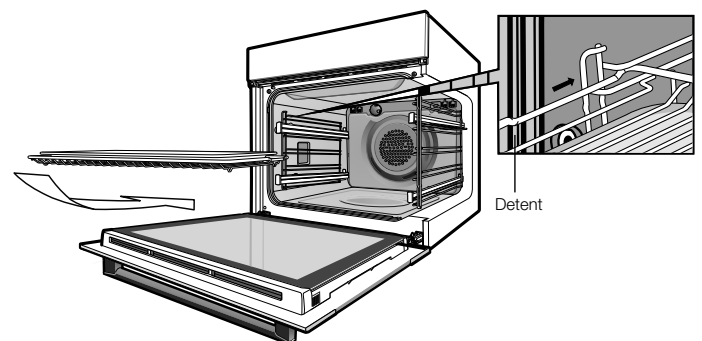

4. When fully inserted the shelf should not interfere with the closed oven door.

## INSTALLING YOUR OVEN ACCESSORIES (CONTINUED)

### To fit a shelf or tray to telescopic slides:

1. Push the shelf or tray along the top of the slide until it hits the back post.

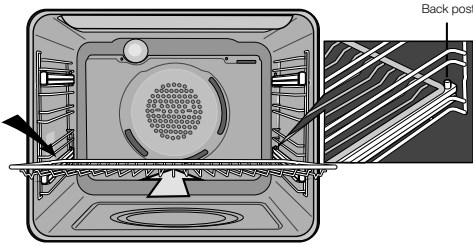

2. Drop the front of the shelf or tray onto the slide ensuring it sits behind the front post of the slide.

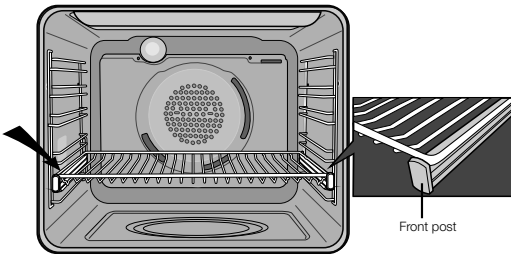

3. When fully inserted the shelf/tray should not interfere with the closed oven door.

### Shelves and trays (WVE655 only)

- To insert the grill tray in a separate grill underbench product, open the grill door and fully extend the grill drawer. Position the grill tray so that the slots on the outer edges fit over the tabs on the slides.

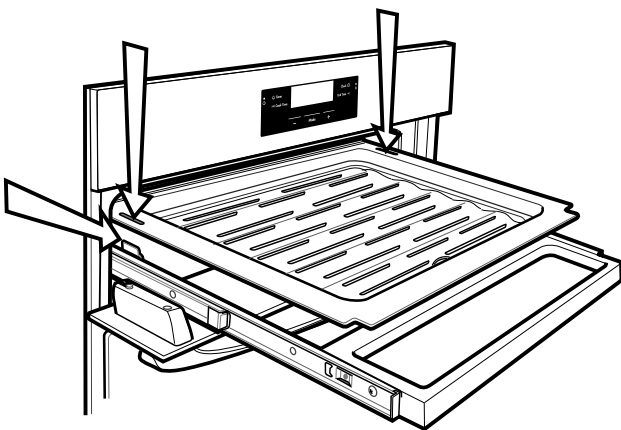

### Air Fry (For applicable models only)

The Air Fryer can be placed onto slides or into side racks in the same manner as an oven shelf.

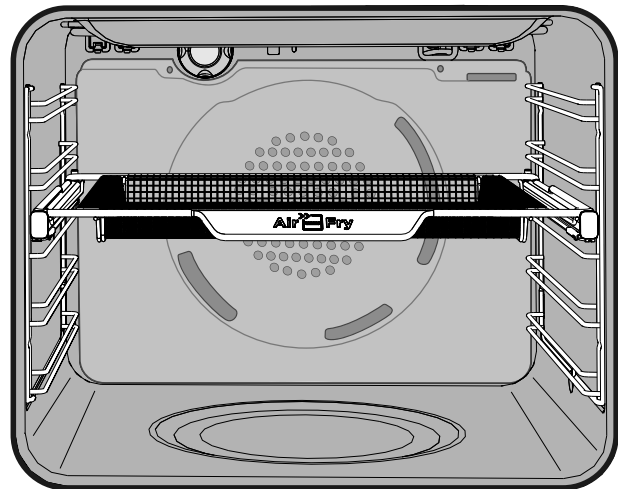
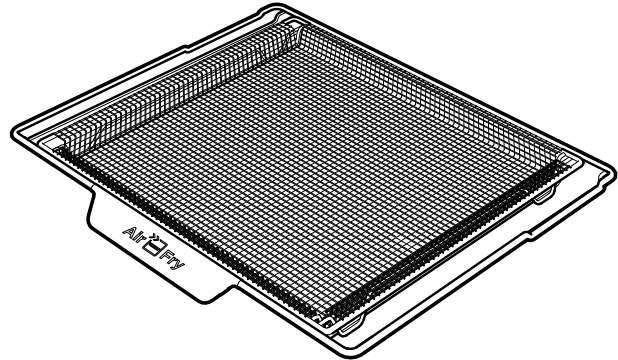



# USING YOUR OVEN

## Understanding your oven functions

Your oven will have a selection of the following functions. Refer to “Description of your appliance” to confirm what functions are available to you.

### Large oven

#### Rapid Heat

Heat comes from the element surrounding the fan as well as the smaller element above the food. This allows you to preheat your oven 30% quicker than with standard “Bake”. “Rapid heat” is ideal for cooking frozen pre-cooked foods such as savoury pastries, pizzas, mini meals (TV dinners), meat pies and fruit pies. Simply place the food in the oven straight from the freezer and heat – ideal for busy people.

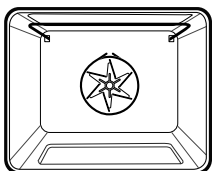

#### Air Fry

Air fry enables advanced convection cooking function without having to turn the food, giving crispy great tasting results in a shorter time without all the oil. This is suitable for french fries, chicken wings, nuggets and similar products.

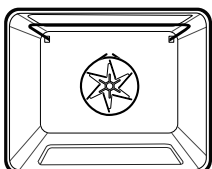

#### Fan Forced (Fan Bake for WVEP618 model)

Heat comes from the element surrounding the fan. This fan circulates the hot air around the oven cavity so that you can put your food in different places in the oven and still cook them at the same time. You can use the “Fan Forced” function for multi-shelf cooking, reheating cooked foods, pastries and complete oven meals. It will cook at a lower temperature and be faster than baking. Please note that some variation in browning is normal.

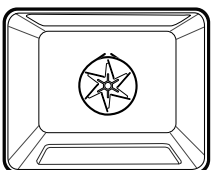

#### Bake

Heat comes from two elements, one above and one below the food. The bottom element is a clean heat element and is below the floor of the oven. Both elements are controlled by the thermostat and will turn on and off to maintain the set temperature. You can use the “Bake” function for a single tray of biscuits, scones, muffins, cakes, slices, casseroles, baked puddings, roasts and delicate egg dishes.

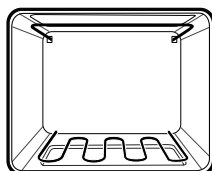

#### Steam Assisted Cooking (WVEP618 model only)

Perfect for all kinds of meat, poultry and fish dishes. The hot air ensures the outside of the food is sealed whilst the steam keeps the inside tender. Steam comes from the outlet pipe and heat comes from the element surrounding the fan. This fan circulates the hot air and steam around the oven cavity so that you can position the food anywhere in the oven. The browning of meat or fish will be perfect, with the best cooking result at the core. Shape will be preserved and evenly firm. Vegetables will retain a high level of nutrients.

*NOTE: Steam will only start if the water tank has been filled and the oven temperature is above 130°C.*

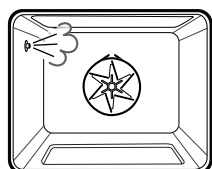

#### Base Heat

Heat comes from the element below the food. The element is controlled by the thermostat and will turn on and off to maintain the set temperature. The “Base heat” function can be used to add extra browning to the bases of pizzas, pies and pastries. Cook in the lower half of the oven when you are using only one shelf. For best results, use silver or shiny trays.

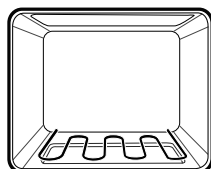

## USING YOUR OVEN (CONTINUED)

### Fan Assist

Heat comes from two elements, one above and one below the food. The fan circulates the hot air around the oven cavity so that you can put the food in different places in the oven and still cook them at the same time. You should only use a maximum of 2 shelves with "Fan assist". Do not use the bottom shelf. If two shelves are used, the food on the shelf in the higher position will cook first and should then be removed to allow the food on the lower shelf to finish cooking.

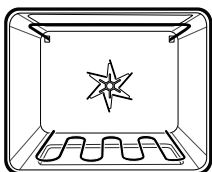

### Pizza

"Pizza" is a combination of "Base heat" and "Fan bake" and offers you the combined benefits of both functions. Heat comes from the element surrounding the fan as well as the clean heat element below the oven floor. The "Pizza" function is ideal for foods that require cooking and browning on the base. It is great for foods such as pizzas, quiches, meat pies and fruit pies. Simply place the food in the middle of the oven and set the desired temperature.

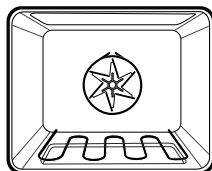

### Defrost

The "Defrost" function uses low temperature air which is circulated by the fan. You can defrost (thaw) your food before you cook it. Also you may use "Defrost" to raise yeast dough or to dry fruit, vegetables or herbs.

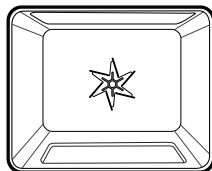

### Fan & Grill (grill in oven models only)

"Fan & Grill" offers you the benefits of both "Bake" and traditional "Grill" functions. The grill element turns on and off to maintain the set temperature while the fan circulates the heated air. The oven door remains closed for "Fan & Grill". You can use "Fan & Grill" for large cuts of meat in the oven which gives you a result that is similar to "rotisserie" cooked meat. Put your food on a shelf in the second lowest shelf position. Put the grill dish on the lowest shelf position to catch any spills. When using "Fan

& Grill" it is not necessary to turn the food over during the cooking cycle. Set temperature to 180°C.

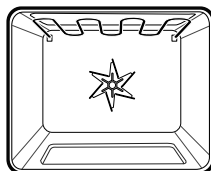

### Grill (grill in oven models only)

"Grill" directs radiant heat from the powerful upper element onto the food. You can use the "Grill" function for tender cuts of meat, steak, chops, sausages, fish, cheese toasties and other quick cooking foods. Grill with the oven door closed. Preheat your grill for 3 minutes to get the best results. This will help seal in the natural juices of steak, chops etc. for a better flavour. You can slide your grill dish into either of the 2 spaces within the upper pairs of support rails.

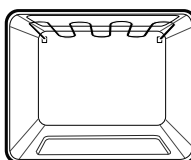

### Quick Cook

The "Quick Cook" function is ideal for cooking frozen precooked foods such as savoury pastries, pizzas, mini meals (TV dinners), meat pies and fruit pies. Heat comes from the element surrounding the fan as well as a smaller element above the food. Simply place the food in the oven straight from the freezer and heat. Cook in the upper half of the oven for best results.

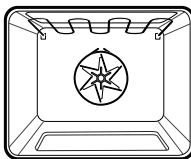

### Roast

The "Roast" function is designed for roasting meats, poultry and fish by utilising heat from all elements in combination with the fan to surround the food. This provides even cooking throughout and enhanced browning.

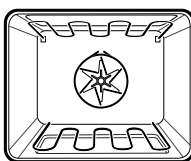

### Maxi Grill (grill-in-oven models only)

“Maxi grill” directs radiant heat from 2 powerful upper elements onto the food. You can use the “Maxi grill” function for tender cuts of meat, steak, chops, sausages, fish, cheese toasties and other quick cooking foods. Grill with the oven door closed. “Maxi grill” allows you to take full advantage of the large grill dish area and will cook faster than normal “Grill”. For best results it is recommended to preheat your grill for 3 minutes. This will help seal in the natural juices of steak, chops etc. for a better flavour.

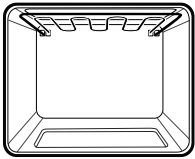

### Pyro Clean (WVEP615, WVEP617, WVEP618 & WVEP627 models only)

The “Pyrolytic cleaning” function is used for cleaning the main oven. It cleans by burning off the spatters and accumulated dirt and grease from the oven liner at high temperature. This process produces ash which can be wiped out of the oven cavity.

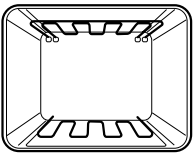

## Small oven/grill

### 1. Bake (duo small oven only)

Heat comes from two elements, one above and one below the food. The bottom element is a clean heat element and is below the floor of the oven. Both elements are controlled by the thermostat and will turn on and off to maintain the set temperature. You can use the “Bake” function for a single tray of biscuits, scones, muffins, cakes, slices, casseroles, baked puddings, roasts and delicate egg dishes.

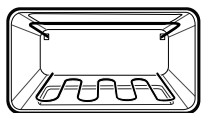

### Fan Assist (duo small oven only)

Heat comes from two elements, one above and one below the food. The fan circulates the hot air around the oven cavity to deliver very even cooking.

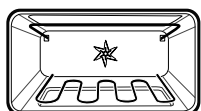

### Grill (small oven only)

The “Grill” directs radiant heat from the powerful upper element onto the food. You can use the “Grill” function for tender cuts of meat, steak, chops, sausages, fish, cheese toasties and other quick cooking foods. Preheat your grill for 3 minutes to get the best results. This will help seal in the natural juices of steak, chops etc. for a better flavour. The grill dish should be positioned between the upper pair of support rails.

*NOTE: Grill with the grill door open.*

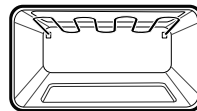

### Split Grill (small oven only)

The “Split grill” works in the same way as a full width grill but with the added advantage of being able to optimise the energy usage for smaller servings.

*NOTE: Grill with the grill door open.*

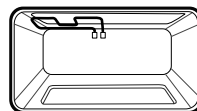

## USING YOUR OVEN (CONTINUED)



### IMPORTANT

#### Cooling/Venting fan

This appliance is fitted with a cooling fan. This prevents your kitchen cabinet from overheating and reduces the condensation inside the oven. It will operate whenever you are using the oven and blow warm air across the top of the oven door.

*NOTE: For selected models only. When setting delayed start, the cooling fan will operate as soon as the function is selected. This will minimise condensation build up in the appliance.*

#### Condensation and steam

This appliance is supplied with an exclusive system which produces a natural circulation of air and the constant recycling of steam. This steam makes it possible to cook in a steamy environment ensuring that dishes are soft inside and crusty on the outside. This process also reduces cooking time and energy consumption. During cooking, steam may be produced and released when the door is opened. This is absolutely normal. When food is heated, it produces steam in the same way a boiling kettle does. When steam comes into contact with the oven door glass, it will condense and produce water droplets. To reduce condensation, ensure that the oven is pre-heated before placing food in the oven cavity. It is recommended that condensation is wiped away after each use of the oven.

#### The effects of dishes on cooking results

Dishes and tins vary in their thickness, conductivity, colour etc. which affects the way they transfer heat to the food.

- Aluminium, earthenware, oven glassware and bright shiny utensils reduce cooking and base browning.
- Enamelled cast iron, anodized aluminium, aluminium with non-stick interior and coloured exterior and dark, heavy utensils increase cooking and base browning.
- To increase base browning simply lower the shelf position. To increase top browning, raise the shelf position.
- Always place dishes centrally on the shelf to ensure even browning.
- Single level cooking gives best results in conventional modes. If cooking on more than one level use a fan cooking function.

#### Operating your oven temperature selector (selected models only)

A thermostat controls the temperature in your appliance. The temperature can be selected within the specified range. To set the temperature, turn the temperature selector in a clockwise direction to the desired setting. An indicator light above the temperature selector will come on. When the set temperature is reached, the element switches off and the indicator light goes off. When the

oven temperature falls below the set temperature, the element switches on and the oven indicator light comes on again.



### CAUTION

Once the food is cooked, turn the temperature selector back in an anti-clockwise direction. Do not force it right round in a clockwise direction as this will result in damage to the thermostat.

*NOTE: For multifunction ovens the desired cooking function must be selected before the oven will operate. Once the desired function has been selected, use the temperature selector to set the required temperature.*

#### Pre-heating your appliance

For best results when baking you must pre-heat the oven for 30 minutes. Pre-heat the grill for 3 minutes to obtain best results. Pre-heating your appliance allows it to reach the required temperature quickly and efficiently. When baking bread or cakes, load the oven as quickly as possible after pre-heating and leave the oven door open for the shortest time. This will minimise loss of heat from the oven and ensure the best results.

#### Pre-heating with “Rapid Heat” (selected models only)

For electric multifunction appliances preheat your oven by selecting the “rapid heat” function. This function allows your oven to reach the preset temperature quicker than any other cooking function.

- Turn the function selector to “Rapid Heat”.
- Set the desired pre-heat temperature, by rotating your oven temperature selector. When the indicator light goes out the oven has reached the desired preset temperature. Select the oven function you require for cooking or baking and place your food into the oven.

#### Pre-heating with other functions

- It is recommended you preheat your appliance when cooking or baking.
- Set the desired pre-heat temperature, by rotating your oven temperature selector. When the indicator light goes out the oven has reached the desired preset temperature, place your food into the oven.

#### Pre-heating “grill”

- Preheat the grill for at least 3 minutes to obtain best results. This will help to seal the natural juices of steak, chops and other meats for a better flavour.

## Cooking with your timer (selected models only)



### CAUTION

Set the timer clockwise. Do not force anticlockwise or damage to the timer will result.

### 120 minute “Auto off” timer

The 120 minute timer features an automatic oven cut off. This means that a cooking period of up to 120 minutes can be set. When the timer has counted back to “Auto off”, a bell will sound and the oven will automatically switch off.

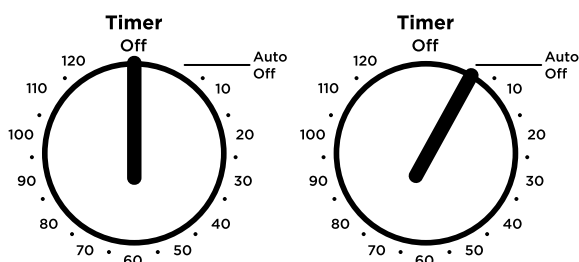

Once automatic baking is complete, return to manual operation by setting the timer to the “OFF” mark.

### Operating the electronic clock (WVE615, WVE616, WVE617, WVE625, WVE636, WVE655, WVE665)

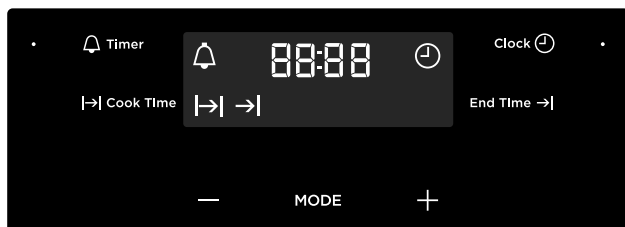

### General features

The oven is equipped with an electronic clock that can be used to turn the oven on and off automatically. The **Cook Time** function automatically turns the oven off after a set amount of time. The **End Time** function is used to set the time of day you want the cooking cycle to finish. A “Delayed start” is possible by combining the **Cook Time** and **End Time** features to switch the oven on and off at a specific time during the day.

*NOTE: Your touch control clock only operates with your main oven.*

### Setting the time

Before the appliance can be used, the time must be set.

After the appliance has been electrically connected, “12:00” will be displayed and the ⌚ clock icon will flash.

To set the time of day in hours and minutes, touch the **−** or **+** symbols. Refer to the diagram above.

5 seconds after the last change, the clock symbol will disappear, confirming the time has been set. Once the time has been entered, the clock advances minute by minute.

*NOTE: The clock has a 24 hour display.*

### Changing the time of day

1. Press **MODE** until the “Clock” indicator symbol ⌚ begins flashing.
2. To set the time of day, press the **−** or **+** symbols while the “Clock” indicator symbol ⌚ is flashing.
3. After 5 seconds from the last change, the “Clock” indicator symbol ⌚ will disappear, confirming the time has been set.

### Setting the minute minder

1. Press **MODE** until the “Timer” indicator symbol ⏰ begins flashing.
2. Set the countdown time by using **−** and **+** symbols while the “Timer” indicator symbol ⏰ is flashing.
3. After 5 seconds from the last change, the “Timer” indicator symbol ⏰ will stop flashing, confirming the timer has been set. The countdown time remaining will appear on the display.
4. Once the set time has elapsed, a beeper will sound for 1 minute. The time indication “0.00” and a flashing “Timer” indicator symbol ⏰ will appear on the display.
5. To stop the beeper, press **−**, **+** symbols or **MODE**.

*NOTE: This feature has no effect on the oven operation. With the minder operating, the time of day cannot be displayed.*

### Setting the cooking duration

1. Select the desired oven **Function** and **Temperature**. The oven indicator light will appear and the heating source will switch on.
2. Press **MODE** until the **Cook Time** indicator symbol ⏱ begins flashing.
3. Set the cooking duration by using **−** or **+** symbols while the **Cook Time** indicator symbol ⏱ is flashing.
4. After 5 seconds from the last change, the **Cook Time** indicator symbol ⏱ will stop flashing, and the time of day will be displayed.

*NOTE: Do not forget to add pre-heating time if necessary.*

### Setting the cooking end time

1. Select the desired oven **Function** and **Temperature**.
2. Press **MODE** until the **End Time** indicator symbol ⏱ begins flashing.

## USING YOUR OVEN (CONTINUED)

- Enter the time of day to finish cooking by pressing **-** or **+** symbols while the **End Time** indicator symbol **→|** is flashing.
- After 5 seconds from the last change, the **End Time** indicator symbol **→|** will stop flashing and the current time of day will be displayed.

### Setting the delayed start cooking time

- Program the **Cook Time** and **End Time** as described in the relevant sections. Once both the **Cook Time** and **End Time** have been set, the **Cook Time** and **End Time** indicators will stop flashing and the current time of day will be displayed.

*NOTE: Do not forget to add pre-heating time if necessary.*

### To check or cancel settings

- To check your settings, press **MODE** until the indicator symbol flashes next to the mode (**Cook Time**, **End Time** etc) that you want to display. After 5 seconds from the last change, the indicator will stop flashing and the time of day will be displayed.
- To cancel "delayed start", press **MODE** until the indicator symbol flashes next to **End Time**. Press and hold **+** and **-** symbols together until the current time of day is displayed.
- To cancel a setting, press **MODE** until the indicator symbol flashes next to the setting to be cancelled. Press and hold **-** and **+** symbols together until the setting is cleared.

### On completion of cooking

When the set time has elapsed, the oven will turn off, the timer will beep and the **End Time** and/or **Cook Time** indicators will flash.

- Turn the **Function** and **Temperature** controls to the off position.
- Press **-** or **+** symbols or **MODE** to stop the clock from beeping.

### Switching the clock display ON and OFF

- Press together **-** and **+** symbols for 3 seconds to switch off the display.
- Press together **-** and **+** symbols for 3 seconds to switch the clock display on again.

*NOTE: If a timer mode is set, then it is not possible to switch the display off.*

### Operating the Electronic Clock (WVEP615, WVEP627, WVEP617)

Before the appliance can be used, the time must be set.



When power is supplied to the oven the clock icon will be displayed. Along with the clock symbol the '12' will be flashing. This indicates that 'hour' portion of the time is ready to be changed.

Toggle the temp selector **+** or **-**, then touch when you have the right hour.

The minutes will flash and can be set in the same manner. 5 seconds after the last change, the clock display will stop flashing, confirming that the time has been set.

*NOTE: The clock has a 24 hour display.*

### Select the oven function

Turn the oven function selector clockwise to select the desired oven function.

*NOTE: each oven function has a default temperature which can then be adjusted as outlined below.*

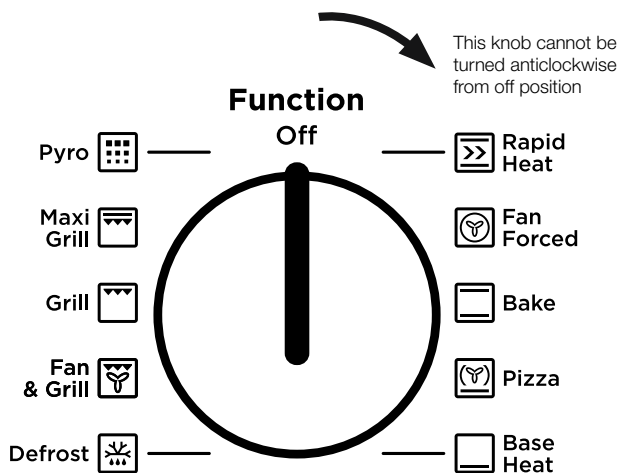

## Selecting the oven temperature

Toggle the temperature selector (left **-** or right **+**) as required to set the desired cooking temperature in °C.

*NOTE: the temperature can be adjusted at any time throughout the cooking time.*

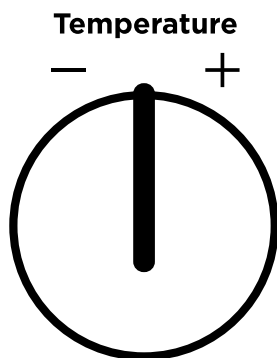

## Cooking with the timer

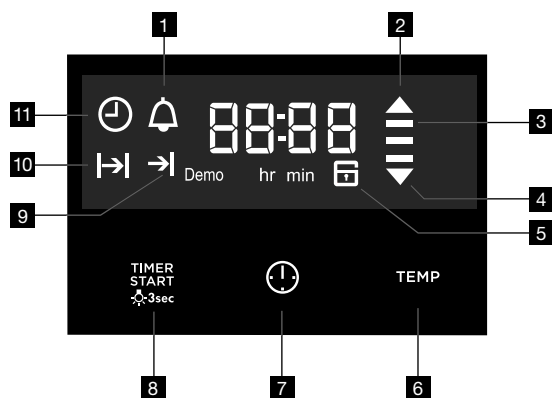

- 1** On when the timer is set
- 2** On when oven warming up
- 3** 3 bars displayed when oven reaches set temperature
- 4** On when oven cooling down
- 5** Oven door locked
- 6** Touch to toggle through cooking time & oven set temp
- 7** Touch to toggle through the timer modes
- 8** Touch to start timer mode.  
Hold to turn oven light on/off
- 9** End time icon
- 10** Cook time icon
- 11** Time of day icon

## Adjusting the clock

To change the time, touch and hold the button until the clock symbol begins to flash. The hour display will be ready to change.

Toggle the temp selector **+** or **-**, then touch when you have the right hour.

The minutes will flash and can be set in the same manner.

5 seconds after the last change, the clock display will stop flashing, confirming that the time has been set.

*NOTE: The clock has a 24 hour display.*

## Setting the cook time

1. Use the knobs to select the desired oven function and cooking temperature.
2. Touch the button as often as necessary, until the 'cook time' symbol appears.
3. Set the desired cooking time commencing with minutes by using **+** or **-**, whilst the symbol is flashing, then touch the button again and set the hours by using **+** or **-**. After 5 seconds from the last time adjustment the symbol will stop flashing. The appliance is now programmed and the display will countdown to zero.
4. When the set time has elapsed, a signal will sound and the appliance will turn off. To stop the signal, touch any button on the clock and then turn the oven function selector to OFF.

*NOTE: Cooking time cannot be set for the Rapid Heat function.*

*The feature can be cancelled at any time by returning the function selector to OFF.*

## Setting the end time

1. Use the knobs to select the desired oven function and cooking temperature.
2. Touch the button as often as necessary, until the 'end time' symbol appears.
3. Set the desired end time commencing with hours using **+** or **-** whilst the symbol is flashing, then touch the button again and set the minutes by using **+** or **-**. After 5 seconds from the last time adjustment the symbol will stop flashing and the appliance is now programmed.
4. When the set time has elapsed, a signal will sound and the appliance will turn off. To stop the signal, touch any button on the clock and then turn the oven function selector to OFF.



*NOTE: Stop time cannot be set for the Rapid Heat function.*

## Setting the delayed start cooking time

The 'cook time' and 'end time' functions can be combined to switch the oven on and off at a specific time during the day.

1. Use the knobs to select the desired oven function and cooking temperature.
2. Touch the button as often as necessary, until the 'cook time' symbol appears.
3. Set the desired cooking time by using **+** or **-**, whilst the symbol is flashing.

## USING YOUR OVEN (CONTINUED)

4. Touch the  button as often as necessary, until the 'end time'  symbol appears flashing.
5. Set the desired switch-off time using **+** or **-** whilst the 'end time'  symbol is flashing.
6. 5 seconds after the last change the 'cook time' and 'end time' arrows are lit to confirm that the oven has been programmed.
7. When the delayed start cooking time has elapsed, a signal will sound and the appliance will turn off. To stop the signal, press any button on the clock and then turn the oven function selector to OFF.





*NOTE: Delayed start cooking time cannot be set for the Rapid Heat function.*

*The feature can be cancelled at any time by returning the function selector to OFF.*

### Additional Functionality

Setting the countdown timer

Use this for timing any activity. For example boiling eggs.

1. Touch the  button, the display will flash.
2. Set the countdown time you want by using **+** and **-**. Commence with setting the number of seconds first. The minutes and hours can then be set by subsequently pressing the  button again and adjusting using **+** or **-**. 5 seconds after the last change the timer will stop flashing, confirming the timer has been set.
3. To cancel the timer touch the  button, the display will flash. Then touch and hold  and **TEMP** buttons until the timer is cleared.
4. To stop the beeper, touch any button.

*NOTE: The clock display cannot be selected when the timer is operating.*

### Elapsed Time

When an oven function is selected (other than pyrolytic clean) an elapsed timer commences on the display.

To reset this timer touch and hold both the  and **TEMP** buttons until the timer is reset.

### Displaying the oven temperature

During operation of the oven the current oven temperature during pre-heating of the oven can be displayed by touching the **TEMP** button. During normal operation the set temperature can be reviewed by touching the **TEMP** button.

*NOTE: this temperature will only be displayed for approximately 5 seconds.*

### Light operation

During operation of the oven the light can be switched off by touching and holding the  button until the

light turns off. Also the light can be turned on from the standby state by touching and holding the  button until the light comes on.

### Activating the child-proof lock

When the child lock is engaged, the oven cannot be operated and the door cannot be opened.

1. Switch off the appliance using the function selector switch.
2. Touch and hold the  and **TEMP** buttons at the same time until the word 'SAFE' is displayed and a double beep is sounded. The word SAFE will be replaced by a padlock symbol on the display after 5 seconds.

### Releasing the child-proof lock

Touch and hold the  and **TEMP** buttons at the same time until a double beep is sounded. This will commence to unlock the door and after 5 seconds the oven is ready for use.

### Activating the function lock

The active function can be locked so it is not changed unintentionally.

1. The active function can be locked, to activate touch  and **TEMP** together until 'Loc' is displayed.
2. If the oven is switched off while in 'Loc' it will switch into Child lock mode and the display will show 'SAFE'.
3. Oven can be released the same way as 'Releasing the child proof lock'

### Safety Cut-out feature

The oven automatically switches itself off if the temperature is not adjusted or the appliance is left operating after a period of time. The oven switches itself off after:

- 12.5 hours when the temperature is set less than 120°C.
- 8.5 hours when the temperature is set to 120°C or above, and below 200°C.
- 5.5 hours when the temperature is set to 200°C or above, and below 250°C.
- 3.0 hours when the temperature is set at 250°C.

### DEMO Mode

The oven can be set to operate in a demo mode (e.g. in a retail store). In this mode the display works and functions can be set but the oven does not actually heat. When in this mode the text 'DEMO' will be lit. The following instructions show how to enter and exit 'Demo' mode.

1. Ensure the oven is in the off state. Toggle and hold the selector to **+** until a beep sounds. The 'DEMO' text will begin to flash.
2. Toggle the temperature selector to set the first digit of display to 2. Touch clock to set.



- Repeat step 2 until display shows 24:68. 3 beeps sound and DEMO will be shown.
- To disable DEMO mode repeat steps 1-3.

### Pyrolytic cleaning of the oven cavity

The oven has the Pyrolytic self-cleaning function. It cleans by burning off the spatters and accumulated dirt and grease from the oven liner, at high temperature. This process produces ash which can then be wiped out of the oven cavity.

Pyrolytic cleaning will not remove salt and mineral residue left in the cavity well when water evaporates. It is recommended that the residue is cleaned prior to conducting pyrolytic cleaning cycles. See section 'Cleaning the cavity well'.

### WARNING

**During the pyrolytic cleaning process the oven becomes extremely hot.**

- Please keep small children at a safe distance.
- Never clean non-stick baking trays and tins in the oven during the pyrolytic cycle. High temperatures damage the non-stick coating and poisonous gas is released.
- To prevent damage, do not use acids, sprays or similar cleaning agents.

### CAUTION

- During pyrolytic cleaning the air outlet exhaust above the door must be kept clear of any obstruction (e.g. bulky tea towels).**
- Do not use the oven to clean miscellaneous items (e.g. cookware).**

### Before carrying out the Pyrolytic function

- All accessories must be removed from the oven, including shelves, trays and side racks.
- Clean large deposits, spills or grease from the oven cavity.
- Ensure the cavity well is free of limestone scaling (refer to cleaning the cavity well chapter)
- Choose the Pyrolytic cleaning cycle from the following:

soiling	duration
light clean	1hr 30mins
normal clean	2hr 30mins

*NOTE: Duration includes heat-up time, excluding cool-down time.*

#### Light clean

This is an energy saving cycle that can be used on a regular basis if the oven is lightly soiled. Possibly after every 2nd or 3rd roast.

#### Normal clean

Use this as the regular cycle about once every 2-3 months.

### Pyrolytic Cleaning Operation

The pyrolytic cleaning function can be selected by turning the function selector switch clockwise to the pyrolytic position. Use **+** or **-** to toggle between a pyrolytic cleaning time of 1:30 hours or 2:30 hours. The pyrolytic function can be stopped at any time by turning the function selector counterclockwise to the OFF position.

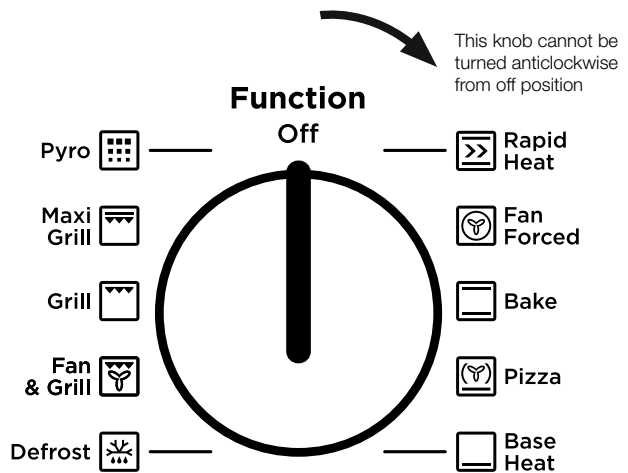

### IMPORTANT

**During Pyrolytic cleaning the door will automatically lock when the temperature in the oven approaches 300°C.  will appear on the display. During the pyrolytic cleaning cycle there may be some burn off odours. It is advised to keep the room well ventilated during this cycle.**

When the pyrolytic cleaning function is on, it is advisable not to use a cooktop if it is fitted above the oven. This could cause overheating and damage to both appliances.

The door will only unlock when the oven has cooled to a safe temperature. Turning the function off will not unlock the door. This will only happen when safe temperature is reached.

*NOTE: The cooling fan will operate at an increased speed for Pyrolytic cleaning and will continue to run until the oven has cooled down. This is normal. It is recommended to clean the oven regularly to keep it in its best condition.*

#### After Pyrolytic cleaning

After cool-down, wipe the ash out of the oven with a soft damp cloth and warm water.

To restore the enamel shine to more difficult areas, use a damp cloth with vinegar and detergent.

### CAUTION

**Do not turn off the mains power supply to the oven during the pyrolytic cycle. This could damage the appliance.**

# USING YOUR OVEN (CONTINUED)

## Operating the Programmable Controller (WVEP618)

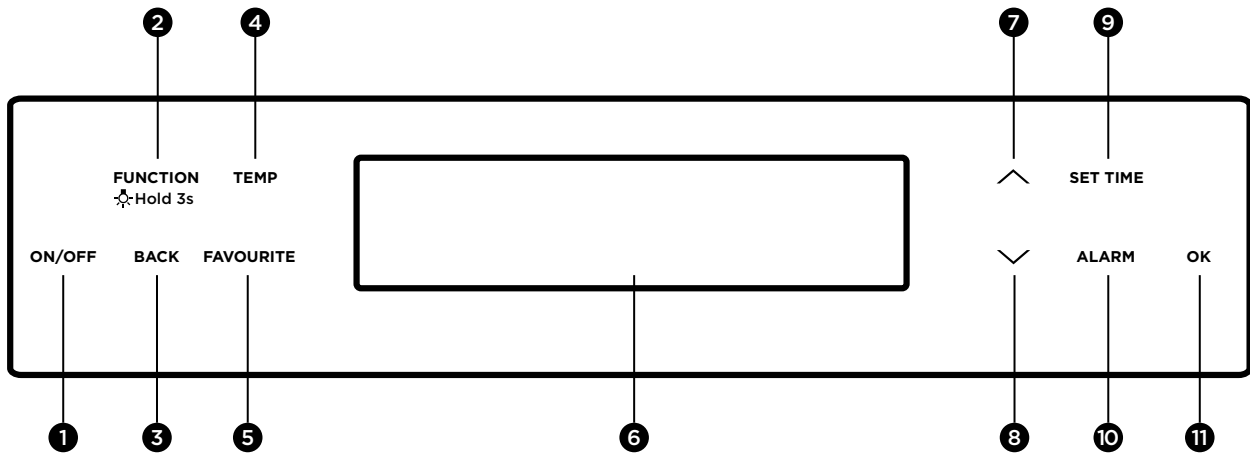







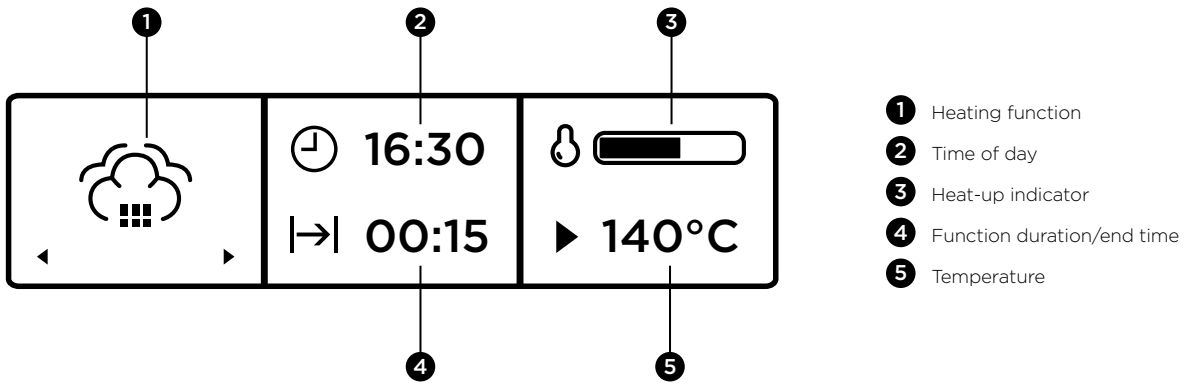

Use the sensor fields to operate the oven.

	FUNCTION	DESCRIPTION
1	ON/OFF	To turn the oven on and off
2	Heating functions or Assisted Cooking	Press the sensor field once to choose a heating function. To turn the light on or off, press the sensor field for 3 seconds
3	Back	To go back one level in the menu. To show the main menu, touch the field for 3 seconds
4	Temperature selection/Fast Heat Up	To set the temperature or show the current temperature in the oven. Press the field for 3 seconds to turn the "Fast Heat Up" function on or off
5	Favourites	To save and access your favourite programs
6	Display	Shows the current settings of the oven
7	Up	To move up in the menu
8	Down	To move down in the menu
9	Time and additional functions	To set different functions. when a heating function operates, press the sensor field to set the timer or the "Function Lock" or "Favourites" functions
10	Minute minder	To set the "Minute Minder" function
11	OK	To confirm the selection or setting

## Display



Other indicators of the display:

SYMBOL	FUNCTION	DESCRIPTION
	Minute minder	The function is currently working
	Time of day	The display shows the current time
	Duration	The display shows the necessary time for cooking
	End time	The display shows when the cooking time will be complete
	Temperature	The display shows the temperature
	Time indication	The display shows how long the heating function works. Press $\wedge$ and $\vee$ at the same time to reset the time
	Heat-up indicator	The display shows the temperature in the oven
	Fast heat up	The function is on. It decreases the heat up time

## USING YOUR OVEN (CONTINUED)

### Before first use

#### Initial cleaning

Remove all accessories and removable shelf supports from the oven.

Refer to “Care and cleaning” chapter.

Clean the oven and the accessories before first use. After cleaning, put the accessories and the removable shelf supports back to their initial position.

#### First connection

When you connect the oven to the mains or after the power is cut, you have to set the display contrast, the display brightness and the time of the day.

1. Press  $\wedge$  or  $\vee$  to set the value
2. Press OK to confirm

#### Preheating before first use

New appliances can have an odour during first use. It is recommended to ‘run in’ the oven before cooking for the first time. Operate the oven(s), empty. Set the function to “Fan Bake” at a temperature of 180°C for approximately 30 minutes.

Please ensure that the room is well ventilated during this process.

### Daily Use















#### Navigating the menus

1. Turn on the oven
2. Press  $\wedge$  or  $\vee$  to select the menu option
3. Press OK to move to the submenu or accept the setting



At each point you can go back to the main menu with **BACK**

### Submenu for “Basic Settings”

SYMBOL	FUNCTION	DESCRIPTION
	Set time of day	Sets the current time on the clock.
	Time indication	When ON, the display shows the current time when you deactivate the appliance.
	Fast heat up	When ON, the function decreases the heat-up time.
	Time extension	Activates and deactivates the time extension function.
	Display contrast	Adjusts the display contrast.
	Display brightness	Adjusts the display brightness.
	Buzzer volume	Adjusts the volume of press-tones and signals by degrees.
	Key tones	Activates and deactivates the tone of the touch fields. It is not possible to deactivate the tone of the ON/OFF touch field.
	Alarm/error tones	Activates and deactivates the alarm tones.
	Cleaning reminder	Reminds you when to clean the appliance (Pyrolytic models only).
	DEMO mode	Activation/deactivation code: 2468.
	Service	Shows the software version and configuration.
	Factory settings	Resets all settings to factory settings.
	Back	Back to previous menu

## USING YOUR OVEN (CONTINUED)

### Setting a heating function

1. Turn on the oven.
2. Select a heating function.
3. Press **OK** to confirm.
4. Set the temperature.
5. Press **OK** to confirm.

### Heat-up indicator

When you turn on a heating function, the bar on the display comes on. The bar shows that the temperature increases. When temperature is reached the buzzer sounds 3 times and the bar flashes and then disappears.

### Fast Heat Up

This function decreases the heat-up time.

Do not put food in the oven when the Fast heat up function works.

To turn on the function, hold **TEMP** for 3 seconds. The heat-up indicator alternates.







This function is not available for some oven functions.

### Residual heat

When you turn off the oven, the display shows the residual heat. You can use the heat to keep the food warm.

## Clock functions

### Clock functions table

Symbol	Clock function	Application
	Minute Minder	To set a countdown (max. 2 h 30 min). This function has no effect on the operation of the oven. Use  to turn on the function. Press  or  to set the minutes and <b>OK</b> to start.
	Duration	To set how long the oven works (max. 23 h 59 min).
	End Time	To set the switch-off time for a heating function (max. 23 h 59 min).

If you set the time for a clock function, the time starts to count down after 5 seconds.



If you use the clock functions: Duration, End Time, the oven turns off the heating elements after 90% of the set time. The oven uses the residual heat to continue the cooking process until the time ends (3 - 20 minutes).

### Setting the clock functions

 Before you use the functions: Duration, End Time, you must set a heating function and temperature first. The oven turns off automatically.

You can use the functions: Duration and End Time at the same time if you want to automatically turn on and turn off the oven on a given time later.

The functions: Duration and End Time do not work when you use the core temperature sensor.

1. Set a heating function.
2. Press **SET TIME** again and again until the display shows the necessary clock function and the related symbol.
3. Press  or  to set the necessary time.
4. Press **OK** to confirm.

When the time ends, a signal sounds. The oven turns off. The display shows a message.

5. Press any symbol to stop the signal.

### Time Extension

The function: Time Extension makes the heating function continue after the end of Duration.



1. When the cooking time ends, a signal sounds. Press any symbol. The display shows the message.
2. Press **SET TIME** to turn on or **BACK** to cancel.
3. Set the length of the function.
4. Press **OK**.

## Additional Functions

### Favourites

You can save your favourite settings, such as duration, temperature or heating function. They are available in the menu: Favourites. You can save 20 programs.

### Saving a program

1. Turn on the oven.
2. Set a heating function or an automatic program.
3. Press **FAVOURITE** again and again until the display shows: **SAVE**.
4. Press **OK** to confirm.  
The display shows the first free memory position.
5. Press **OK** to confirm.
6. Enter the name of the program. The first letter flashes.
7. Press  or  to change the letter.
8. Press **OK**. The next letter flashes.
9. Do step 7 again as necessary.
10. Press and hold **OK** to save.

You can overwrite a memory position. When the display

shows the first free memory position, press or and press to overwrite an existing program.

You can change the name of a program in the menu: Edit Program Name.

### Activating the program

1. Turn on the oven.
2. Press **FAVOURITE**.
3. Select your favourite program name.
4. Press **OK** to confirm.

### Using the Child Lock

When the Child Lock is on, the oven cannot be turned on accidentally.

If the Pyrolysis function works, the door locks automatically. A message comes on in the display when you press any symbol.

1. Press **ON/OFF** to turn on the display.
2. Press **TEMP** and **FAVOURITE** at the same time until the display shows a message. To turn off the Child Lock function, repeat step 2.

### Function Lock

This function prevents an accidental change of the heating function. You can turn it on only when the oven works.

1. Turn on the oven.
2. Set a heating function or setting.
3. Press **TEMP** again and again until the display shows: Function Lock.
4. Press **OK** to confirm.

If the Pyrolysis function works, the door is locked and the symbol of a key comes on in the display.

To turn off the function, press **TEMP**. The display shows a message. Press **TEMP** again and then **OK** to confirm.

When you turn off the oven, the function also turns off.

### Automatic Switch-Off

For safety reasons the oven turns off automatically after some time, if a heating function works and you do not change any settings.

Temperature (°C)	Switch-off time (h)
30 - 115	12.5
120 - 195	8.5
200 - 245	5.5
250 - maximum	3
Pyrolytic Cleaning	4.5

 The Automatic Switch-off does not work with the functions: Light, Food Sensor, Duration, End Time.

### Brightness of the display

There are two modes of display brightness:

- Night brightness - when the oven is turned off, the brightness of the display is lower between 10pm and 6am.
- Day brightness:
  - when the oven is turned on.
  - if you touch a symbol during the night brightness (apart from **ON/OFF**), the display goes back to the day brightness mode for the next 10 seconds.
  - if the oven is turned off and you set the function: Minute Minder. When the function ends, the display goes back to the night brightness.

### Cooling fan

When the oven operates, the cooling fan turns on automatically to keep the surfaces of the oven cool. If you turn off the oven, the cooling fan can continue to operate until the oven cools down.

### Hints and tips

The temperature and baking times in the tables are guidelines only. They depend on the recipes and the quality and quantity of the ingredients used.

### Advice for special heating functions of the oven

#### Keep warm

Use this function if you want to keep food warm. The temperature regulates itself automatically to 80°C.

#### Baking

For best baking results preheat oven for 30 minutes.

Your oven may bake or roast differently to the appliance you had before. Adapt your usual settings such as temperature, cooking time and shelf position to the values in the tables.

Use the lower temperature the first time.

If you cannot find the settings for a special recipe, look for the similar one.

You can extend baking times by 10-15 minutes if you bake cakes on more than one shelf position.

Cakes and pastries at different heights do not always brown equally at first. If this occurs, do not change the temperature setting. The differences equalise during the baking procedure.

Trays in the oven can twist during baking. When the trays become cold again, the distortions disappear.

## USING YOUR OVEN (CONTINUED)

### Oven shelves



#### IMPORTANT

- Select the correct shelf location for food being cooked.
- Make sure dishes will fit into the oven before you switch it on.
- Keep edges of baking dishes at least 40mm from the side of the oven. This allows free circulation of heat and ensures even cooking.
- Do not open the oven door more than necessary.
- Do not place foods with a lot of liquid into the oven with other foods. This will cause food to steam and not brown.
- After the oven is turned off it retains the heat for some time. Use this heat to finish custards or to dry bread.
- Do not use a lot of cooking oil when roasting. This will prevent the splattering of oil on the sides of the oven and the oven door. Polyunsaturated fats can leave residue which is very difficult to remove.
- When cooking things which require a high heat from below (e.g. tarts), place the cooking dish on a scone tray in the desired shelf position.
- For sponges and cakes use aluminium, bright finished or non-stick utensils.
- Always remove unnecessary trays or dishes when roasting or baking.

Use the oven efficiently, by cooking many trays of food at the same time. For example:

- Cook 2 trays of scones, small cakes or sausage rolls.
- Cook a roast dinner at the same time as you cook chips or vegetables.

It is not recommended to use more than 2 shelves at a time. When cooking with 2 shelves use an oven fan function.

### Roasting meat

- Place the meat in the oven and set the temperature between 180°C and 200°C. (It is recommended to wrap your meats in an oven roasting bag or foil to prevent fats and oils from splattering, making it easier to clean your oven.)
- Use the grill/oven dish and grill insert. Place the meat on the insert.
- Do not pierce the meat, as this will allow juices to escape.
- When the meat is cooked, take the roast out of the oven, wrap in aluminium foil and leave to stand for about 10 minutes. This will help retain the juices when the meat is carved.

The table shows temperatures and cooking times for different kinds of meat. These may vary depending on the thickness or bone content of the meat.

MEAT	RECOMMENDED TEMPERATURE °C	RESULT	MINUTES PER KG
Beef	200	Rare	35 - 40
		Medium	45 - 50
		Well done	55 - 60
Lamb	200	Medium	40
		Well done	60
Veal	180	Well done	60
Pork	200	Well done	60

### Roasting poultry and fish

- Place the poultry or fish in an oven set at a moderate temperature of 180°C.
- Place a layer of foil over the fish for about three quarters of the cooking time.

The table shows temperatures and cooking times for different kinds of fish and poultry. These may vary depending on the thickness or bone content of the meat.

MEAT	RECOMMENDED TEMPERATURE °C	MINUTES PER KG
Chicken	180	45 - 50
Duck	180 - 200	60 - 70
Turkey	180	40 - 45 (<10kg)
		35 - 40 (>10kg)
Fish	180	20

### Oven shelf location

The oven has 5 positions for shelves (as shown in the diagram below). To give maximum space above and below the shelves, load them in this way:

When cooking with 1 shelf, position at 1 or 2.

When cooking with 2 shelves, position them at 2 and 4.

For more detailed shelf locations. Refer to cooking tables for individual cooking functions.

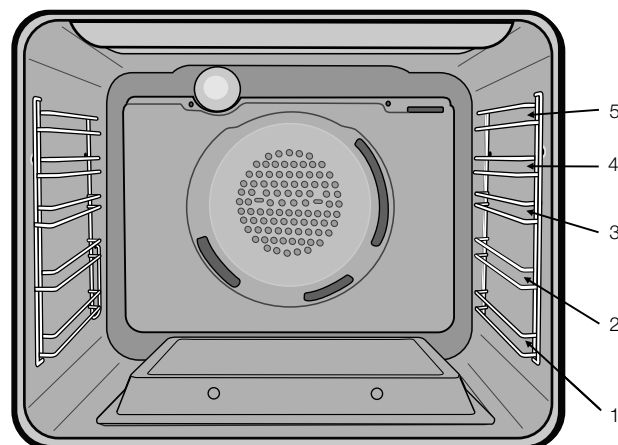



# COOKING GUIDE

## Choosing the best oven settings

The following table is intended as a guide and experience may show some variation in cooking times necessary to meet individual requirements. It may be necessary to change some cooking times and temperatures from your previous oven. For best results when baking preheat your oven for 30 minutes.

### Conventional cooking

FOOD		TEMPERATURE°C	OVEN SHELF POSITION*	TIME IN MINUTES
Scones	Plain or fruit	220	2 or 3	10 - 15
Biscuits	Rolled	180	2 or 3	10 - 15
	Spooned	190	2 or 3	12 - 15
	Shortbread biscuits	160	2 or 3	30 - 35
Meringues	Hard - individual	110	2 or 3	90
	Soft - individual	180	2 or 3	15 - 20
	Pavlova - 6 egg	110	2	75
Cakes	Patty cakes	190	2 or 3	15 - 20
	Sponge - 4 egg	180	2 or 3	20 - 30
	Shallow butter cake	180	2 or 3	30 - 40
	Rich fruit cake	150	2 or 3	180
Pastry - shortcrust	Cornish pasties	200/180	2 or 3	40 - 45
	Custard tart	200/180	2 or 3	10/20 - 30
Pastry - choux	Cream puffs	210	2 or 3	25 - 30
Yeast goods	Bread	210	2 or 3	25 - 30

### Fan forced cooking

FOOD		TEMPERATURE°C	OVEN SHELF POSITION*	TIME IN MINUTES
Scones	Plain or fruit	210	1 & 4	10 - 15
Biscuits	Rolled	170	Any	10 - 15
	Spooned	180	Any	12 - 15
	Shortbread biscuits	150	Any	30 - 35
Meringues	Hard - individual	100	Any	90
	Soft - individual	165	Any	15 - 20
	Pavlova - 6 egg	100	1 & 4	75
Cakes	Patty cakes	180	1 & 4	15 - 20
	Sponge - 4 egg	170	1 & 4	20 - 30
	Shallow butter cake	170	Any	30 - 40
	Rich fruit cake	130	1	180
Pastry - shortcrust	Cornish pasties	180/160	Any	40 - 45
	Custard tart	190/170	Any	20 - 30
Pastry - choux	Cream puffs	200	Any	25 - 30
Yeast goods	Bread	200	1	25 - 30

### Air Fry Cooking†

FOOD		TEMPERATURE°C	OVEN SHELF POSITION*	TIME IN MINUTES
Scotch fillet steak, seared first		220	2 or 3	8 (med/rare)
Frozen chips		220	2 or 3	15
Chicken drumettes/wingettes, with dry rub		220	3	15
Fresh barramundi fillet with crumb		210	3	15
Potatoes cut into wedges		220	3	20
Frozen goods (Chicken nuggets/crumbed fish)		220	3	15
Smashed chats parboiled		220	3	15

\* Counting from the bottom shelf up.

†A tray should be placed on the bottom shelf position, covered with foil, to catch any fat.

# GRILLING GUIDE

## Grilling hints



### WARNING

Always clean the grill/oven dish after every use. Excessive fat build up may cause a fire.

As a method of cooking, grilling can be used to:

- Enhance the flavours of vegetables, fish, poultry and meat.
- Seal the surface of the food and retain the natural juices.

*NOTE: Below is a table indicating the door position whilst grilling for each of the product types.*

DESCRIPTION	DOOR POSITION DURING GRILLING
Grill in oven	Door FULLY closed
Separate grill	Door FULLY open

This table shows how to grill different types of meat:

MEAT	METHOD
Beef	You can use tenderloin, rump, sirloin. Brush with oil or melted butter, especially if the meat is very lean.
Lamb	You can use loin chops, shortloin chops, chump chops, and forequarter chops. Remove skin or cut at intervals to stop curling. Brush with oil or melted butter.
Sausages	Prick sausages to stop skin from bursting.
Poultry	Divide into serving pieces. Brush with oil.
Fish	Brush with oil or melted butter and lemon juice.
Bacon	Remove rind. Grill flat.

## Grilling with separate grill underbench

Your separate grill underbench appliance comes with a handle accessory to pull out and push in the grill tray frame.

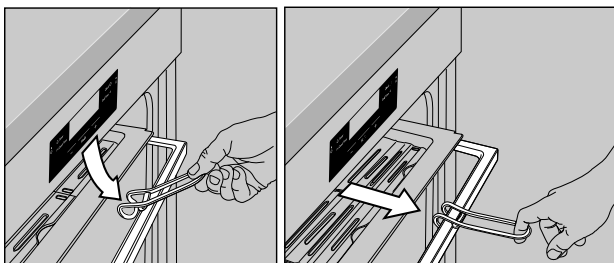

### WARNING

Operating the oven may result in a hot grill tray frame even without the grill being used. As it may be a hot surface, it is not recommended to touch the grill tray frame directly.

## Guide to better grilling



### IMPORTANT

Definite times can not be given for grilling as it is dependant on the size of the food and your own tastes.

These times should only be used as a rough guide and remember to turn the food over halfway through the cooking process (except with fan grill).

For better grilling results, follow these easy instructions:

1. Remove oven/grill dish and grill insert and preheat grill for about 3 minutes.
2. Choose only prime cuts of meat or fish. If the cut is less than 5mm thick it will dry out. If the cut is more than 40mm thick, the outside may burn whilst the inside remains raw.
3. Do not place aluminium foil under the food as this prevents fats and oils from draining away, which could result in a fire.
4. Baste the food during cooking with butter, olive oil or marinade.
5. Use tongs to turn food as a fork pierces the surface allowing juices to escape.

MEAT	TIME
Steak	15 - 20 minutes
Chops	20 - 30 minutes
Fish	8 - 10 minutes
Bacon	4 - 5 minutes

## Fan grill (multifunction grill in oven models only)

If your appliance has fan grill as a function, this will assist the grilling process by circulating the heat evenly around the food. The recommended temperature setting is 180°C for all fan grilling functions.

1. Place the oven/grill dish on the bottom rack.
2. Place meat/poultry on an oven shelf above the oven/grill dish.
3. Wipe off any oil or fat which spatters while the oven is still warm.

There is no need to turn the meat as both sides are cooked at the same time.

## STEAM ASSISTED COOKING

Cooking with steam is a great addition to straight 'hot air' cooking. Steam brings out all the natural flavours and goodness in the food, cooks evenly from surface to centre and retains more nutrients and vitamins. Steam assisted cooking consistently produces juicy, succulent interiors with crisp, golden exteriors.

### **WARNING**

#### **Risk of burns and damage to the appliance**

- Do not open the appliance door when the steam function operates, with the exception of preheating.
- Open the appliance door with care after the steam function stops.
- Refer to cleaning the appliance for cleaning after the steam function operates.

#### **WVE617, WVEP617, WVEP627 models**

1. Open the oven door
2. Add 150ml of tap water to the cavity well. Fill the cavity well with water only when the oven is cold.

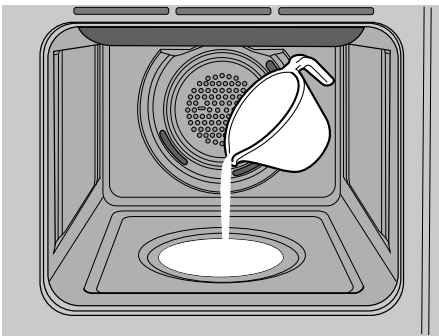

3. Set the "EasyBake + Steam" function for Steam Assisted cooking.

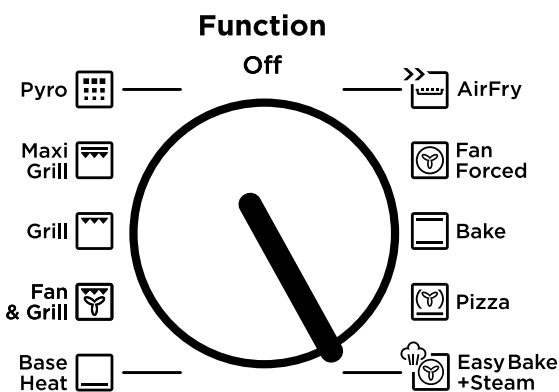

4. Turn the knob for the temperature to select a temperature.
5. Preheat the oven for 10 minutes or according to the recipe suggestions.
6. Place food in the appliance and close the oven door.

### **CAUTION**

Do not refill the cavity well with water during cooking or when the oven is hot.

7. To deactivate the appliance, turn the knob for the oven functions to **OFF** position.
8. Remove water from the cavity well.

### **WARNING**

Make sure that the appliance is cool before you remove the remaining water from the cavity well.

#### **WVEP618 model only**

For hot steam, select Steam Cooking from the main menu. Then select the desired function.

This oven has 4 dedicated steam functions that have been individually tuned to produce the best result with a combination of steam and heat application.

**Steam bake** - Steam comes from the outlet pipe and heat comes from the element surrounding the fan. This fan circulates the hot air and steam around the oven cavity so that you can put your food in different places in the oven. This function is suggested for baking bread or general bakery products.

**Steam reheat** - Great for reheating dishes like rice, pasta and pizza that can suffer from dryness in normal ovens or sogginess in microwave ovens.

**Roast + Steam** - Perfect for all kinds of meat, poultry and fish dishes. The hot air ensures the outside is sealed whilst the steam keeps the inside tender.

**Pizza + Steam** - This function creates a great pizza in terms of crispy crust and uniform browning on top.

#### **Steam operating sequence**

1. Open the water drawer in the control panel by pressing it.
2. Pour approximately 850mL of water into the drawer. Stop filling if alarm sounds and "water tank full" message is displayed.
3. Close the water drawer.

### **WARNING**

Take care when filling the water drawer. Spillage could create a slipping hazard. Immediately clean up any spills on the product, cabinet or floor. If the "water tank full" alarm sounds immediately stop pouring water into the water drawer. If the tank is overfilled the excess will flow into the oven. This prevents leakage onto cabinets and is not a fault. Sponge up overflows if they occur.

## STEAM ASSISTED COOKING (CONTINUED)

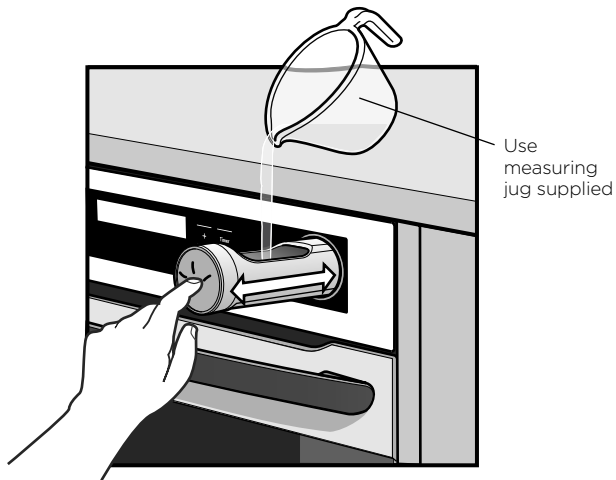

### CAUTION

Do not use any liquid other than normal tap water. Do not use demineralised or distilled water. Doing so could affect the normal operation of the steam generator. Do not put solid matter into the water drawer.

4. Turn on the oven and select the steam cooking function and temperature. Set timer functions if desired.
5. Once the oven has reached the set temperature, place the food in the oven. A full water tank will last approximately 30 minutes. It may have to be refilled during a long cooking cycle, for example a roast.



### WARNING

The steam will not be visible inside the oven when cooking with steam. Opening the oven door to place, remove or inspect the food will release it. Stand back when opening the door to avoid the risk of burns.

6. Once cooking is complete, remove the food and turn off the oven. Leave the oven door ajar to aid drying out the oven.
7. Drain the water tank once the appliance is cool. (See "Emptying water tank")

### Emptying the water tank



### WARNING

Water in the tank can still be hot. Wait until the appliance is cool before the water tank is drained. Do not use the drained water to fill the water tank again.

The water tank must be emptied after every steam assisted cooking cycle.

1. Open the oven door to reveal the water outlet valve.
2. Insert the valve end of the supplied drain pipe into the water outlet valve. Ensure the other end is in a container that can take up to 1 litre.

3. Remove the drain pipe only when the water stops flowing.
4. Soak up any leakages with a sponge or cloth

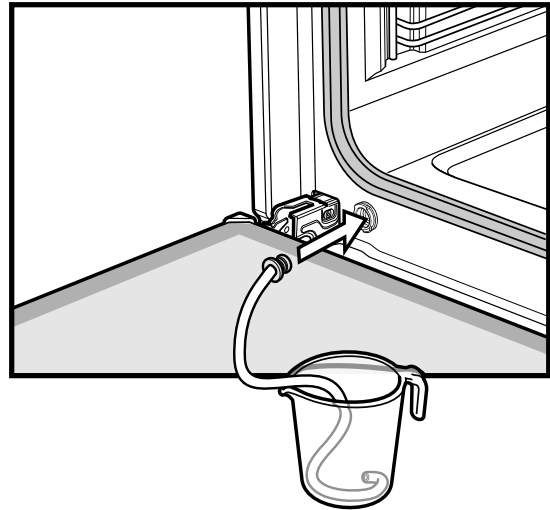

## DEALING WITH COOKING PROBLEMS

PROBLEM	CAUSES	REMEDY
Uneven cooking	<ul style="list-style-type: none"> <li>• Incorrect shelf position</li> <li>• Oven tray too large</li> <li>• Trays not centralised</li> <li>• Air flow in oven uneven</li> <li>• Grill dish affecting thermostat</li> </ul>	<ul style="list-style-type: none"> <li>• Select shelf suitable for cooking function. See cooking function tables in cooking guide</li> <li>• Experiment with other trays or dishes</li> <li>• Centre trays</li> <li>• Rotate food during cooking</li> <li>• Remove grill dish from oven on bake modes</li> </ul>
Baked products too brown on top	<ul style="list-style-type: none"> <li>• Oven not preheated</li> <li>• Baking tins too large for the recipe</li> <li>• Baking tins not evenly spaced</li> <li>• Products not evenly sized or spaced on trays</li> <li>• Baking temperature too high</li> </ul>	<ul style="list-style-type: none"> <li>• Preheat oven</li> <li>• Use correct size tins</li> <li>• Stagger baking tins at least 3cm between tins and oven walls</li> <li>• Make into same size and shape, and spread evenly over trays</li> <li>• Lower the temperature</li> </ul>
Baked products too brown on bottom	<ul style="list-style-type: none"> <li>• Baking tins too large for the recipe</li> <li>• Baking tins are a dark metal or glass</li> <li>• Food too low in the oven</li> <li>• Oven door opened too frequently during baking</li> <li>• Baking temperature too high</li> <li>• Grill dish affecting thermostat</li> </ul>	<ul style="list-style-type: none"> <li>• Use correct size tins</li> <li>• Change to shiny, light tins or lower the temp by 10°C</li> <li>• Cook one shelf higher</li> <li>• Don't open the door until at least half the cooking time has passed</li> <li>• Lower the temperature</li> <li>• Remove grill dish from oven on bake modes</li> </ul>
Cakes have a cracked thin crust	<ul style="list-style-type: none"> <li>• Baking temperature too high</li> <li>• Food too high in oven</li> <li>• Cake batter over mixed</li> <li>• Pan too deep</li> <li>• Baking pans dark</li> </ul>	<ul style="list-style-type: none"> <li>• Lower the temperature</li> <li>• Cook one shelf lower</li> <li>• Mix just long enough to combine ingredients</li> <li>• Check size of pan</li> <li>• Change to shiny pans</li> </ul>
Baked products are pale, flat and undercooked	<ul style="list-style-type: none"> <li>• Baking temperature too low</li> <li>• Food too low in oven</li> <li>• Baking time too short</li> <li>• Incorrect size tin</li> </ul>	<ul style="list-style-type: none"> <li>• Raise the temperature</li> <li>• Cook one shelf higher</li> <li>• Increase the cooking time</li> <li>• Use the correct size tin</li> </ul>
Cakes fallen in the centre	<ul style="list-style-type: none"> <li>• Baking temperature too low</li> <li>• Baking time too short</li> <li>• Proportions of ingredients incorrect</li> <li>• Door opened too early in baking</li> </ul>	<ul style="list-style-type: none"> <li>• Raise the temperature</li> <li>• Increase the cooking time</li> <li>• Check recipe</li> <li>• Do not open door until the last quarter of cooking time</li> </ul>
Roast meat, potatoes not browning in fan oven	<ul style="list-style-type: none"> <li>• Poor air circulation</li> <li>• Grill dish affecting thermostat</li> <li>• Juices running out of meat</li> </ul>	<ul style="list-style-type: none"> <li>• Elevate food onto a rack to allow air circulation</li> <li>• Remove grill dish from oven on bake modes</li> <li>• Do not pierce meat with a fork</li> </ul>
Grilled meats outside is overcooked and centre is raw		<ul style="list-style-type: none"> <li>• Grill at lower insert position</li> </ul>
Grilled chops and steaks curling		<ul style="list-style-type: none"> <li>• Cut into fat every 2cm</li> </ul>
The steam cooking does not operate	<ul style="list-style-type: none"> <li>• There is no water in the tank</li> <li>• Limescale is obstructing the hole</li> </ul>	<ul style="list-style-type: none"> <li>• Fill the water tank</li> <li>• Check the steam outlet opening and remove the lime</li> </ul>
It takes more than three minutes to empty the water tank or the water tank leaks from the steam outlet	<ul style="list-style-type: none"> <li>• There are lime deposits in the appliance</li> </ul>	<ul style="list-style-type: none"> <li>• Check the water tank and refer to the chapter on Cleaning the water tank</li> </ul>
Steam and condensation settle on the food and in the appliance	<ul style="list-style-type: none"> <li>• The dish has been left in the oven for too long</li> </ul>	<ul style="list-style-type: none"> <li>• Do not keep the dishes in the appliance for longer than 15-20 minutes after the cooking ends</li> </ul>

## GETTING TO KNOW THE OVEN

### Get to know the oven with this 'Simple Test Cake'

Although we strive for a perfect performing oven, it's possible that there will be some variation in colour when baking. Therefore, we suggest this simple, easy and delicious to make Simple Test Cake, it can help you understand your new oven. All ovens do sometimes have hot or cold spots, therefore it is important to judge with your eye as you may require to rotate during baking.

#### 'Simple Test Cake'

125g butter, softened to room temperature

1 cup caster sugar

1 teaspoon pure vanilla essence

4 large eggs

2 cups self-raising flour

pinch of salt

4 tablespoons (80mL) full-cream milk

#### Method:

Butter base and sides of 2, 20cm straight-sided round or square cake pans. Then line the base with grease proof or baking paper.

Preheat oven to moderate '180°C' (170°C fan forced) and ensure oven shelf is in the centre position of oven.

Cream softened butter and sugar until light in colour.

Add vanilla essence.

Then add eggs one at a time, beating well after each addition.

Sift flour and salt into the mixture and beat until well combined.

Add milk and beat or stir to combine.

Spoon mixture equally between prepared cake pans.

Bake in preheated oven, middle shelf for about 25 to 35 minutes or until when tested with a fine cake skewer it comes out clean or the edges of the cakes have come away slightly from the sides of the cake pans.

Remove from oven to wire cake rack and rest for 5 minutes before removing from cake pans.  
Cool completely.

To Serve: sandwich together with your favourite jam or conserve, and dust top with pure icing sugar.

*NOTE: If desired substitute butter for either margarine or olive oil spread. Recipe is based on the Australian standard metric 250mL cup and 20mL tablespoon sets.*

## CARE AND CLEANING



### WARNING

Ensure the oven is electrically isolated before cleaning. This can be done by switching off the appliance via the powerpoint or isolating switch (if available), or the switchboard.

Do not use steam cleaners, as this may cause moisture build up.



### CAUTION

Do not use sharp metal implements or utensils on any surface, as these may leave permanent scratches or marks.

### Enamel

Rub persistent stains vigorously with a nylon scourer or creamed powder cleansers.

*NOTE: You can also use household oven enamel cleaners - follow the manufacturer's instructions carefully.*



### CAUTION

Do not use harsh abrasive cleaners, powder cleaners, steel wool or wax polishes on enamel.

Do not line the bottom of the oven or grill with foil or cookware.

### Stainless steel

All grades of stainless steel can stain, discolour or become greasy. You must clean these areas regularly by following the procedures below, if you want your appliance to look its best, perform well and have a long life.



### WARNING

Care must be taken when wiping exposed stainless steel edges...they can be sharp!



### CAUTION

The oven door and control panel are decorated with a special stainless steel that resists finger marks and should only be cleaned with warm water and a mild detergent. DO NOT use stainless steel cleaners, abrasive cleaners or harsh solvents.

*NOTE: Make sure you follow the polish or brushing lines in the steel.*

### Glass

Glass surfaces on doors and control panels are best cleaned immediately after soiling. A damp cloth may help remove baked on food deposits. Oven cleaners can be used to remove stubborn marks and stains.



### WARNING

The door glass on this appliance is made from a tough, durable material that withstands heating and cooling without breaking. As a precaution however, do not put cold water on hot glass. Should you have any questions about the glass in your new appliance, please contact the customer care centre by dialling 1300 363 640.

Door glass that is damaged should be immediately replaced.



### CAUTION

Do not use harsh abrasive cleaners or sharp metal scrapers to clean the oven door glass since they can scratch the surface, which may result in shattering of the glass.

### Oven



### WARNING

Always keep your appliance clean. Ensure that fats and oils do not accumulate around elements, burners or fans. Keep the oven dish, baking trays, grill dish and grill dish insert clean, as any fat deposits may catch fire. Wrap your meats in foil or an oven roasting bag to minimise cleaning. Any polyunsaturated fats can leave a varnish-like residue which is very difficult to remove. The upper element can be released to assist in cleaning.

### Grill



### WARNING

Always keep the grill dish and grill dish insert clean, as any fat deposits may catch fire. Ensure that fats and oils do not accumulate around the grill element. The grill element can be released to assist in cleaning the top of the grill cavity.

### Cleaning your oven accessories

Removing the trays and shelves from your appliance

- Slide the dish and shelves towards you until they reach the front stop.
- Tilt them up at the front to clear the side supports, taking care not to spill the contents.
- For separate grill underbench model (WVE655), open the grill door and pull out the grill slide to its full extent. Carefully lift the dish from the support.
- Lift the dish and shelves clear.
- Wash the dish, insert and shelves in hot soapy water.
- Reverse the above steps to put the grill tray and shelves back again.
- Ensure that they are placed between the 2 support wires.

## CARE AND CLEANING (CONTINUED)

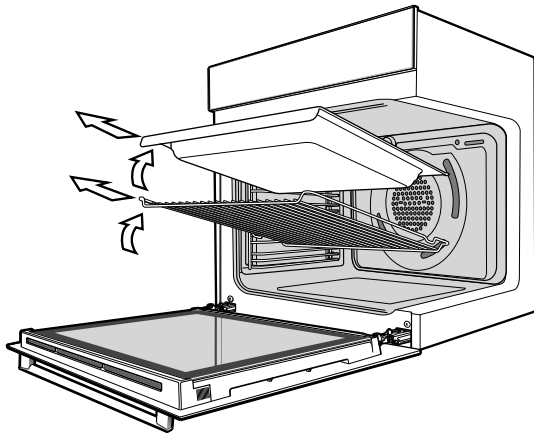

### CAUTION

Do not remove the slide mechanism on the separate grill underbench model (WVE655). The grill dish can easily be removed for cleaning.

### Removing the side racks

1. Grasp the middle wire at the front.
2. Pull firmly inwards while pushing back.

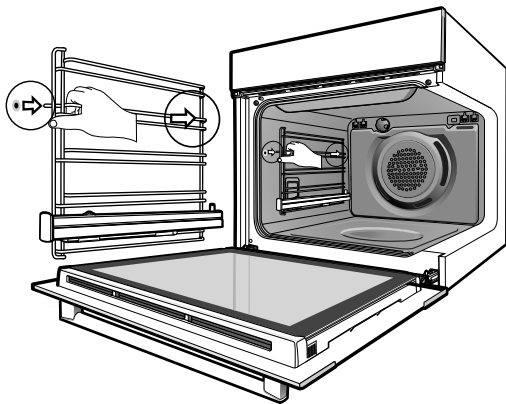

### Slides (Telescopic runners)

- Do not subject slides to temperatures greater than 300°C.
- Do not place slides in a dishwasher
- Do not use a knife or sharp object to clean slides.
- Do not add oil or any other lubricant to slides.

### Removing and replacing the oven back light and side light (where fitted)

- Turn oven light glass anticlockwise to remove it for globe replacement.
- To remove side light, place a spoon under the light glass and lever off. Replace globe and snap glass cover back into position.

- A special high temperature resistant globe should be used. This can be purchased from Electrolux Customer Care Centre.

*NOTE: Light globes are not covered by warranty*

### WARNING

Make sure the appliance is turned off before you remove or replace parts, to avoid the possibility of electric shock.

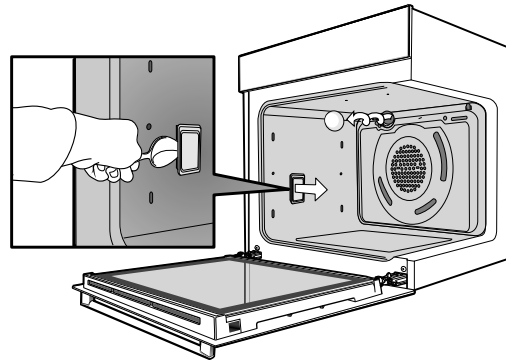

### Releasing the grill element

### WARNING

Make sure the appliance is turned off before you remove or replace parts, to avoid the possibility of electric shock.

Retaining wire models - The upper grill element is secured with a hanger clip which can be removed to help clean the oven cavity ceiling. To remove the hanging clip push the sides of the clip in the direction of the arrows. After cleaning, raise the grill element and secure clip back into position.

*NOTE: Diagram shows a grill in oven model. The procedure is the same for separate grill models which use the same hanger clip in the grill compartment.*

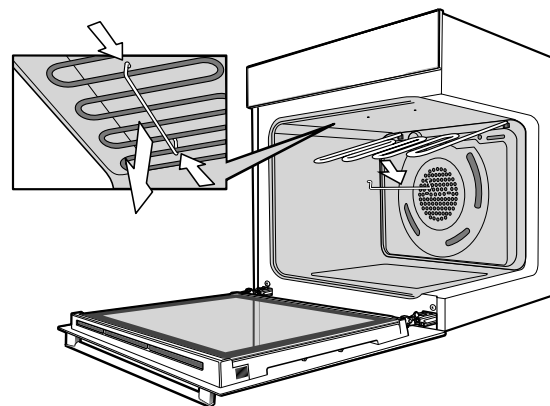

Rotating latch models - rotate latch 180 degrees and the grill element will drop down freely. After cleaning, raise the grill element and secure by rotating the latch back 180 degrees.



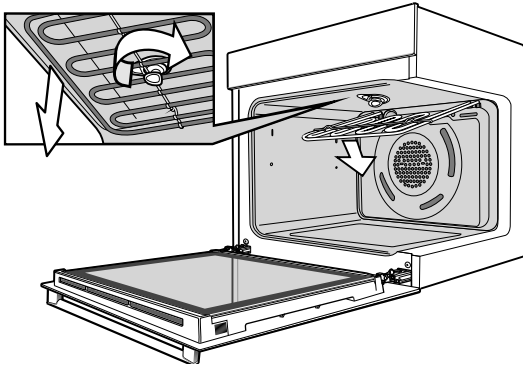

**Cleaning the triple glazed oven door  
(on selected models)**



**CAUTION**

Do not lift the door by the handle. Rough handling will cause glass to break.

**Removing the oven door**



**IMPORTANT**

Your oven is equipped with a door that can be disassembled in order to clean all the panes of glass. Remove the door before cleaning.

- Open the door fully to access the hinges then rotate the 'stirrups' on both hinges fully towards the oven.

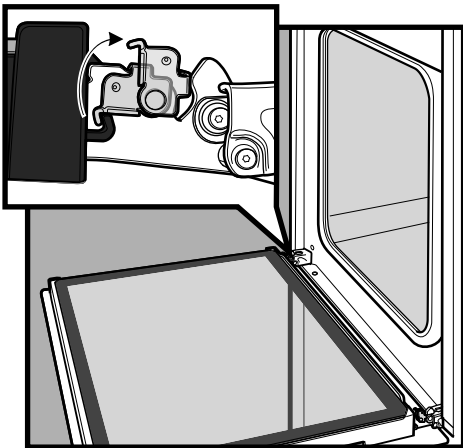

- Slowly close the oven door until it stops against the 'stirrups' (about 45°).

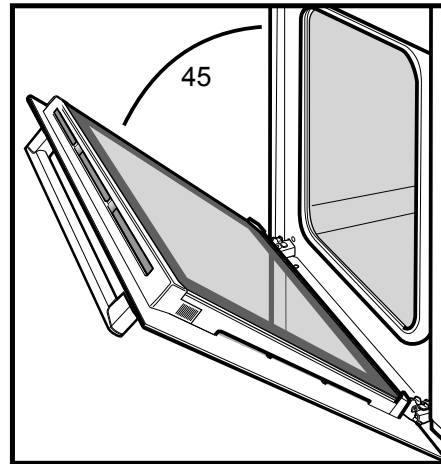

- Grasp the oven door with a hand each side of the door and remove it from the oven by pulling it towards you.

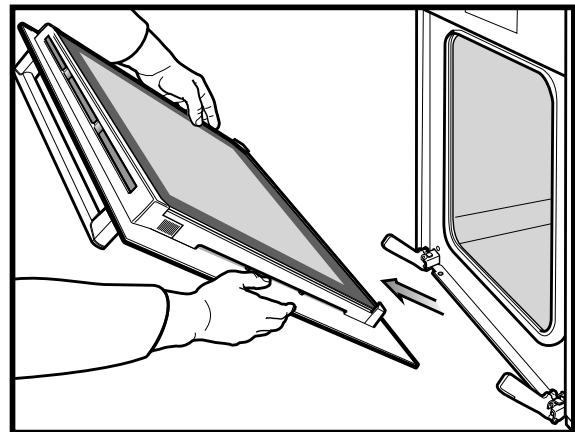

- Lay the oven door with the outer side facing downwards on something soft and flat (for example a blanket on a kitchen table) to prevent scratches.

**Removing oven door top trim**

- Take hold of the grid embossed sections of the door trim at each end and press inwards to release the clips. Remove the door trim by pulling it towards you.

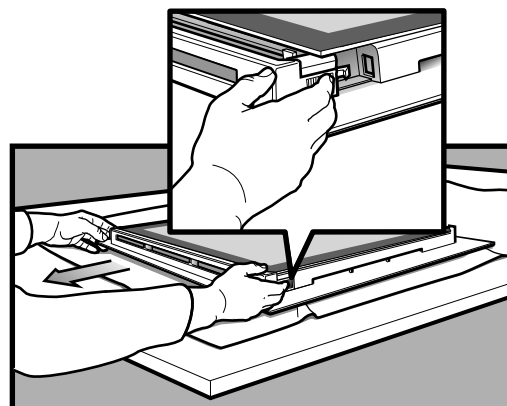

## CARE AND CLEANING (CONTINUED)

### Removing the door glass panels



#### CAUTION

Rough handling, especially around the edges can cause the glass to break.

- Lift the black bordered glass panel out of the guide and place on something soft and flat to prevent scratches.

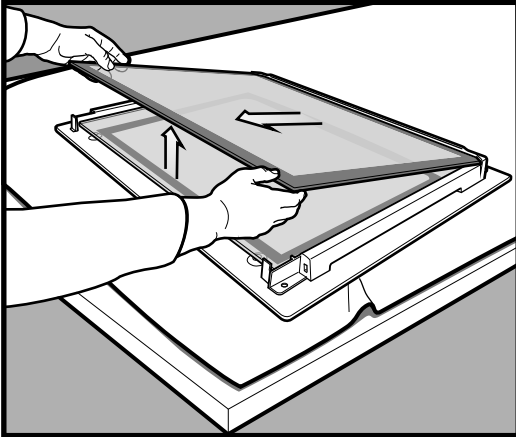

- Repeat this for the smaller clear glass panel (when fitted).

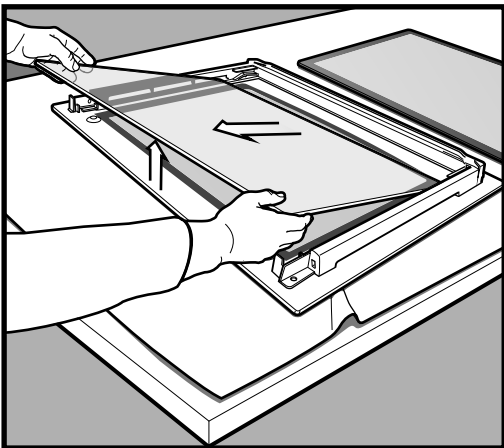

### Cleaning the door glass panels



#### CAUTION

Do not to use harsh abrasives on the glass panes as the reflective surface plays a role in the function of the oven. Do not place glass in dishwasher. Hand wash only with a soft cloth and warm soapy water. When dry polish with a soft cloth and ensure the glass is dry before reassembly.

### Removing bottom trim (on selected models)

- The bottom trim may be removed for cleaning by snapping out and lifting away from the glass.

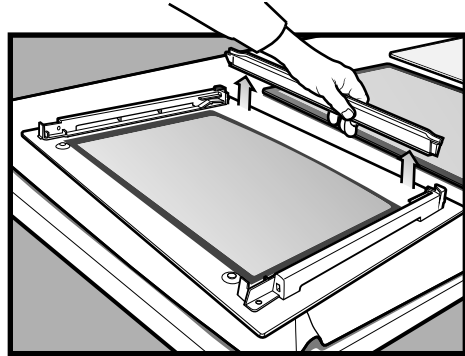

### Re-assembling the bottom trim (on selected models)

- Push down to “snap” each side of bottom trim back into door columns.

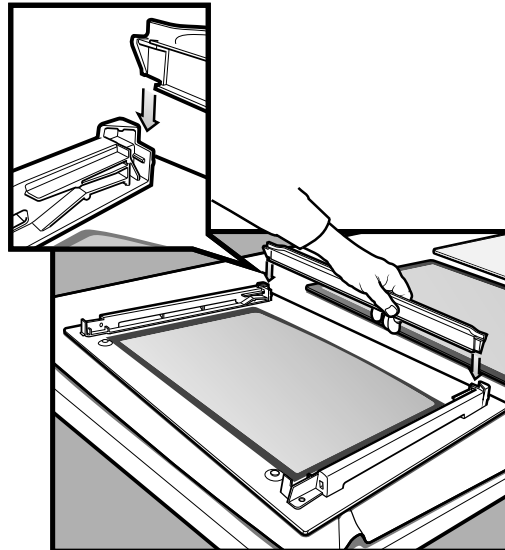

### Re-assembling the door glass panels

- Insert the smaller clear glass panel (when fitted) first from above and at an angle to the profile of the door.

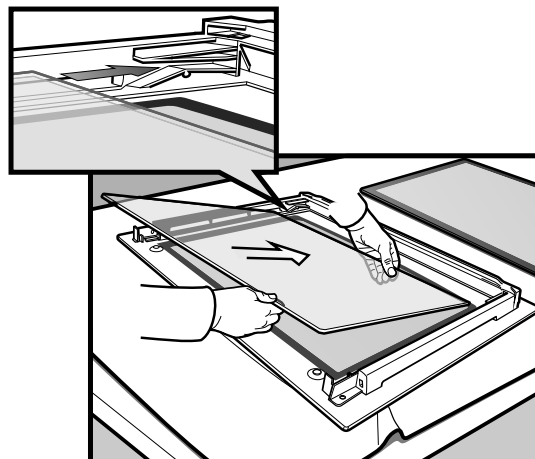

- Repeat for the black bordered glass panel ensuring the painted surface is facing to the downside.

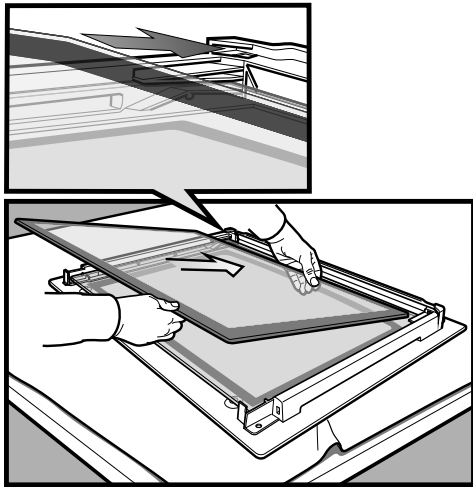

### Re-assembling the top door trim

- Take hold of the top door trim at each side and position it to the inside edge of the glass.
- Push the trim down with its top edge over glass panel until the clip snaps in on each side of the trim.

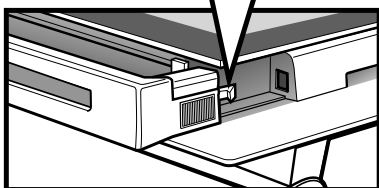
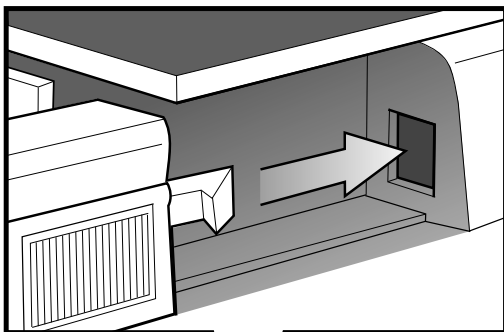

- Push the middle of the trim down to ensure it is straight and firm against the glass panel.

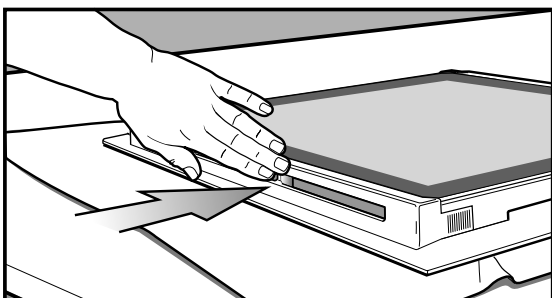

### Fitting the oven door

- Take hold of the oven door with a hand on each side and with the door at an angle of 45°, position the recesses at the bottom of the door onto the hinge arms of the oven. Let the door slide down the hinge arms as far as it will go.

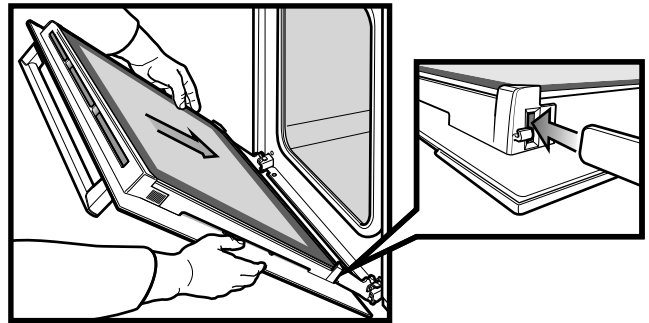

- Open the door fully to access the hinges.
- Rotate the stirrups (see image below) until they lock into the hook. The oven door may now be closed.

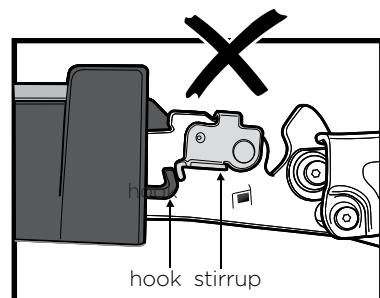
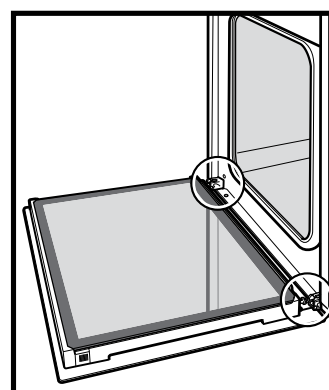
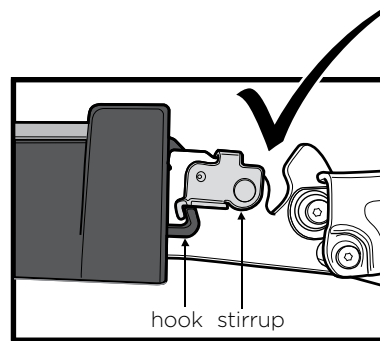

## CARE AND CLEANING (CONTINUED)

### Cleaning the quad glazed oven door (on selected models)



#### CAUTION

Do not lift the door by the handle. Rough handling will cause glass to break.

### Removing the oven door



#### IMPORTANT

Your oven is equipped with a door that can be disassembled in order to clean all the panes of glass. Remove the door before cleaning.

- Open the door fully to access the hinges then rotate the 'stirrups' (highlighted in the image) on both hinges fully to open position.

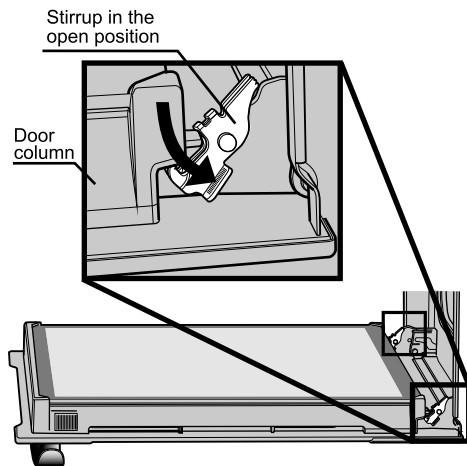

- Slowly close the oven door until it stops against the 'stirrups' (about 30°).

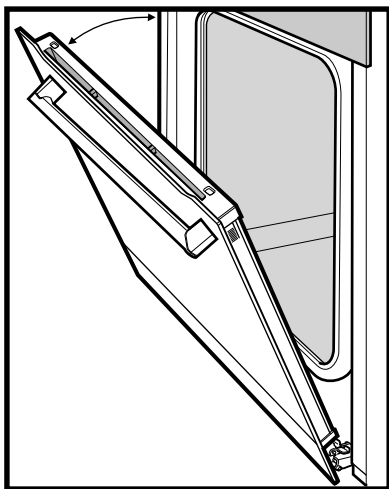

- Hold the oven door with a hand each side and remove it from the oven by pulling it towards you.

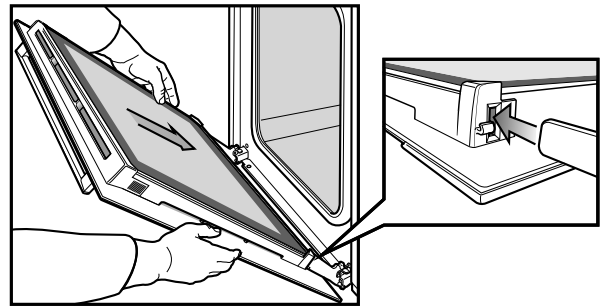

- Lay the oven door with the outer side facing downwards on something soft and flat (for example a blanket on a kitchen table) to prevent scratches.

### Removing oven door top trim

- Hold the embossed sections of the door columns at each end and press inwards to release the clips. Remove the upper door trim by pulling it towards you.

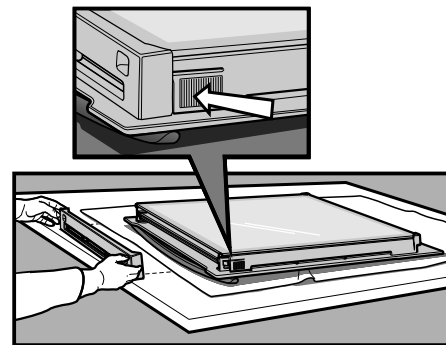

### Removing the door glass panels



#### CAUTION

Rough handling, especially around the edges can cause the glass to break.

- Lift the black bordered glass panel out of the guide and place on something soft and flat to prevent scratches.
- Repeat this for the smaller clear glass panels.
- When removing panel 3, ensure that the two rubber spacers are removed before cleaning. Do not misplace them!

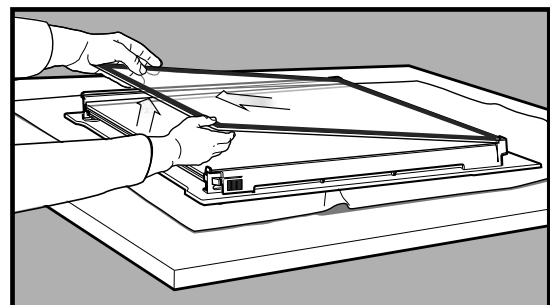

## Cleaning the door glass panels



### CAUTION

Do not use harsh abrasives on the glass panes as the reflective surface plays a role in the function of the oven. Do not place glass in dishwasher. Hand wash only with a soft cloth and warm soapy water. When dry polish with a soft cloth and ensure the glass is dry before reassembly.

## Re-assembling the quad glazed oven door (on selected models)

### Re-assembling the door glass panels

- Assemble the silicone spacers to the upper corners of one of the clear glass panels. Position the panel into the lower position of the door, ensuring the chamfered corner of the panel is placed in the correct location as shown in the image below.

Chamfer to be located in this corner

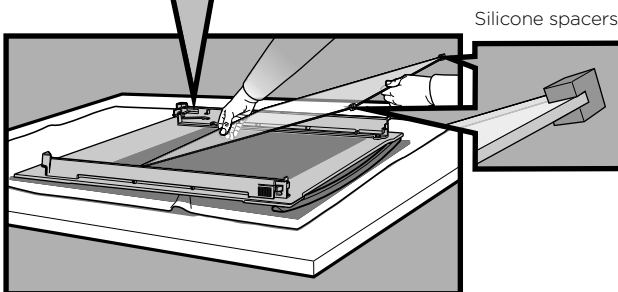
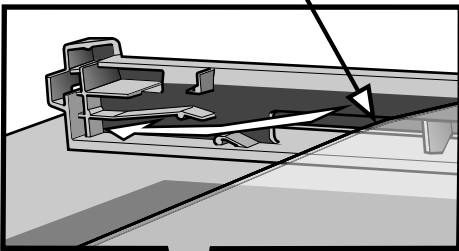

- Insert the remaining smaller clear glass panel into the middle position, ensuring the chamfered corner of the panel is placed in the correct location as shown in the image below.

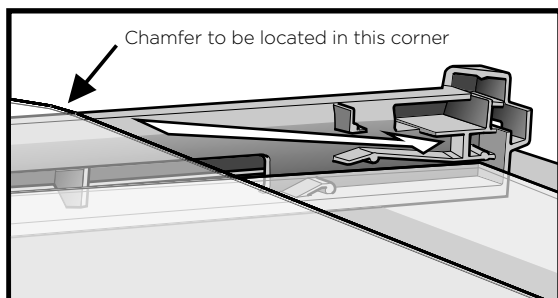

- Insert the black bordered glass panel into the upper position, ensuring the painted surface is facing the downside as per the image below.

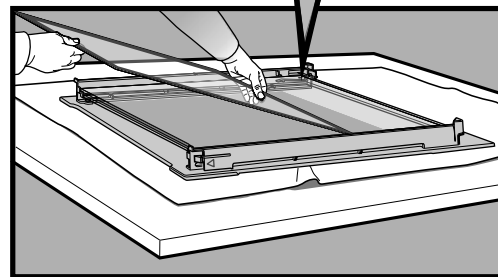
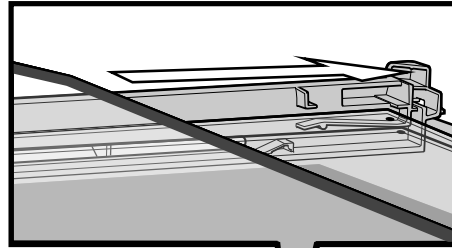

### Replacing the top door trim

- Hold the top door trim at each side and position it to the inside edge of the glass.
- Push the trim down with its top edge over the glass panel until the clip snap in on each side of the trim.
- Push the middle of the trim down to ensure it is straight and firm against the glass panel.

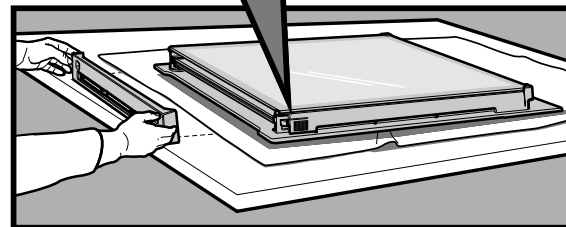
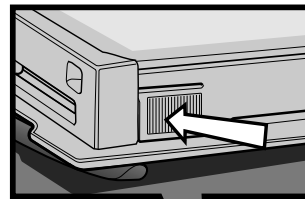

### Fitting the oven door

- Take hold of the oven door with a hand on each side and with the door at an angle of 30°, position the recesses at the bottom of the door onto the hinge arms of the oven. Let the door slide down the hinge arms as far as it will go.

## CARE AND CLEANING (CONTINUED)

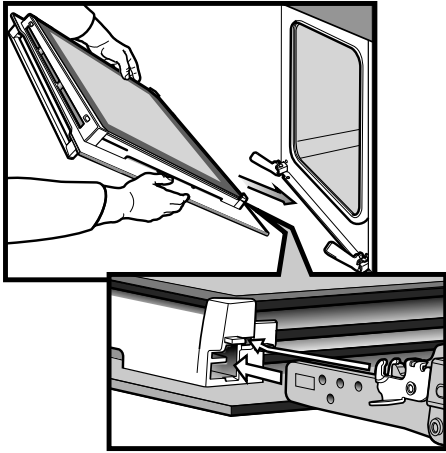

- Open the door fully to access the hinges.
- Rotate the 'stirrups' (see the image below) until they lock into the hook. The oven door may now be closed.

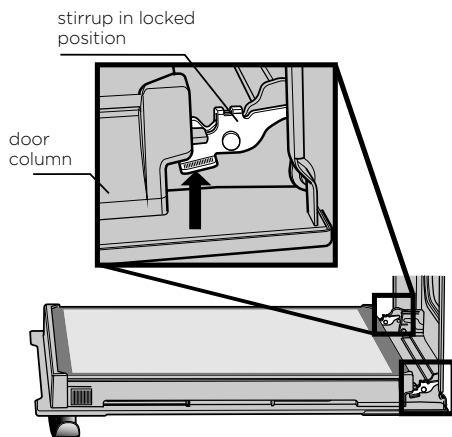

### Cleaning the side open door (on selected models)

Side open door models have been designed to allow for the inner glass panels to be removed for cleaning.

### Removing side open door top trim

Take hold of the grid embossed sections of the door trim at each end and press inwards to release the clips. Then remove the door trim by lifting it upwards.

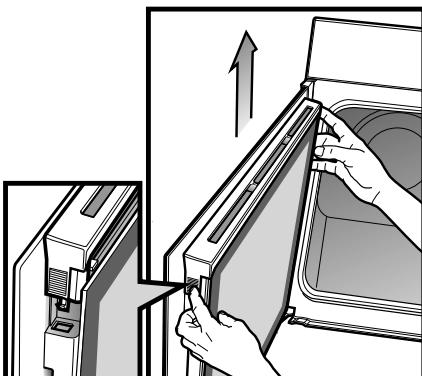

### ⚠ CAUTION

Do not lift the door by the handle. Rough handling will cause glass to break.

### Removing the door glass panels

### ⚠ CAUTION

Rough handling, especially around the edges can cause the glass to break.

- Take hold of the black bordered glass panel with a hand on its upper and lower edge. Lift and rotate the glass around the retainer to remove it from the guide.
- Repeat this for the smaller clear glass panel (when fitted).

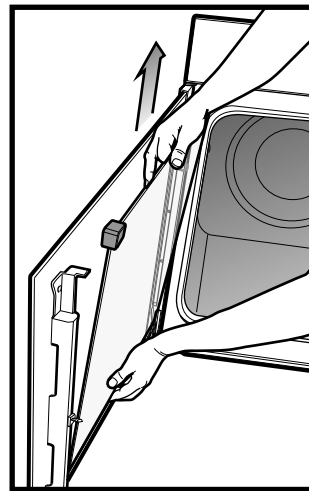

- Take hold of the smaller clear glass panel (when fitted) with a hand on its upper and lower edge. Lift the glass to remove it from the retainer.
- The rubber moulding on the upper corner of the small clear glass panel may be removed. Please take care that it is not misplaced.

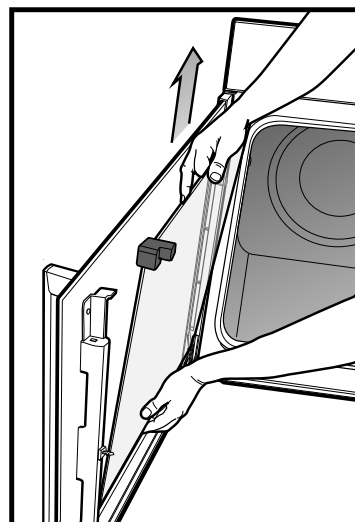

### Cleaning the door glass panels



#### CAUTION

Do not to use harsh abrasives on the glass panes as the reflective surface plays a role in the function of the oven. Do not place glass in dishwasher. Hand wash only with a soft cloth and warm soapy water. When dry polish with a soft cloth and ensure the glass is dry before reassembly.

### Re-assembling the side open oven door (on selected models)

Re-assembling the door glass panels

- Ensure the rubber moulding is placed in the correct orientation on one of the upper corner of the smaller clear glass panel.
- Insert the smaller glass panel (when fitted) first from above and at an angle to the profile of the door.

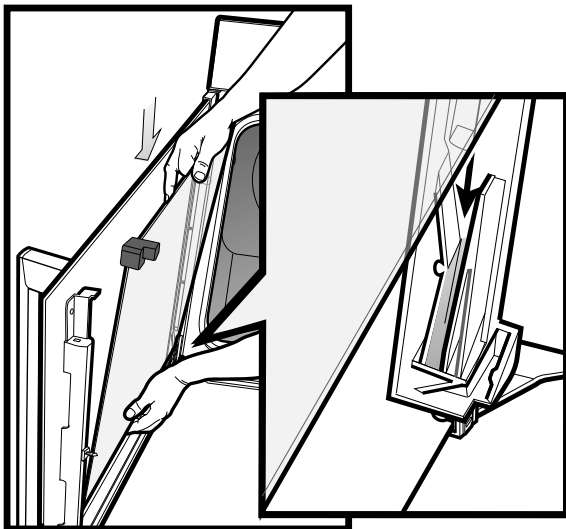

- Repeat for the black bordered glass panel ensuring the painted surface is facing towards the outside of the door.

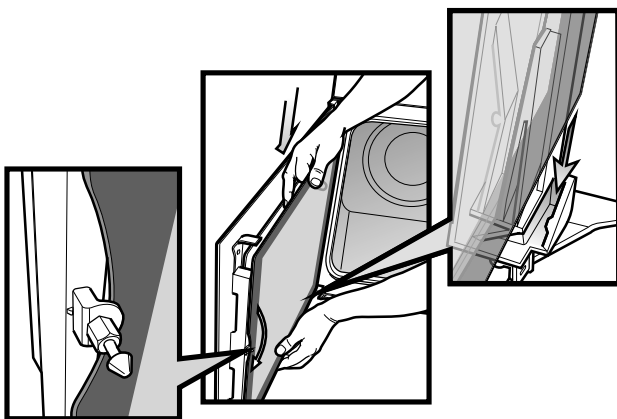

Replacing top door trim

- Take hold of the top door trim at each side and position it to the inside edge of the glass.
- Push the trim down with its top edge over glass panel until the clip snaps in on each side of the trim.

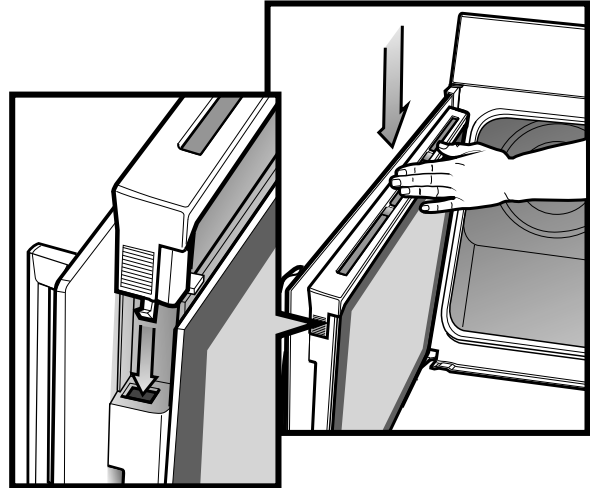

### Pyrolytic Cleaning of the Oven Cavity (WVEP615, WVEP617, WVEP618 & WVEP627 models only)

The oven has the Pyrolytic self-cleaning function, it cleans by burning off the spatters and accumulated dirt and grease from the oven liner, at high temperature. This process produces ash which can then be wiped out of the oven cavity. It is recommended you clean your oven regularly to keep the oven in its best condition.

- Light clean - this is an energy saving cycle that can be used on a regular basis if the oven is lightly soiled. Possibly after every 2nd or 3rd roast.
- Normal clean - use this as the regular cycle about once every 2-3 months.

### Before carrying out the Pyrolytic cleaning function



#### WARNING

- Clean large deposits, spills or grease from the oven cavity.
- Please keep small children at a safe distance. The appliance becomes very hot.
- Never clean non-stick baking trays and tins in the oven during the pyrolytic cycle. High temperatures damage the non-stick coating and poisonous gas is released.
- Pyrolytic cleaning can release fumes that are not harmful to humans, including infants or persons with medical conditions, however you are strongly advised to provide good ventilation during and after each pyrolytic cleaning process.
- Unlike humans, some birds and reptiles can be extremely sensitive to the potential fumes emitted

## CARE AND CLEANING (CONTINUED)

during the pyrolytic cleaning process. It is strongly advised to remove any pets (especially birds) from the vicinity of the appliance during and after each pyrolytic cleaning process.

- Small pets can also be highly sensitive to the localized temperature changes in the vicinity of all pyrolytic ovens when the pyrolytic self cleaning program is in operation.



### CAUTION

- All accessories must be removed from the oven, including shelves, trays and side racks.
- During pyrolytic cleaning the air outlet vent above the door must be kept clear of any obstruction (e.g. tea towels).
- Do not use your oven to clean miscellaneous items (e.g. cookware).
- To prevent damage, do not use acids, sprays or similar cleaning agents.



### IMPORTANT

During the pyrolytic cleaning function, it is advisable not to use a cooktop if it is fitted above the oven. This could cause overheating and damage to both appliances. The cooling fan will operate at an increased speed for pyrolytic cleaning and will continue to run until the oven has cooled down. It is recommended to use the Pyro clean function regularly to keep the oven in its best condition.

#### Starting the Pyrolytic cleaning function (WVEP615, WVEP617 & WVEP627 models only)

- Make sure all accessories are removed from the oven including shelves, trays and side racks.
- Turn the oven "Function" selector clockwise to select the "Pyro" position.
- Use the **+** or **-** buttons on the electronic clock to select between a pyrolytic cleaning time of 1:30 hours (light clean) or 2:30 hours (normal clean) for the appropriate level of cleaning.
- After 5 seconds from the last change, the oven will begin heating and the "Remaining time" will be displayed.
- The pyrolytic cleaning function can be stopped at any time during the cycle by turning the function selector counter-clockwise to the "OFF" position.

*NOTE: The "Remaining time" does not include cool-down time for the oven.*

*NOTE: The bottom oven does not have the pyrolytic cleaning function.*

#### Starting the pyrolytic cleaning function (WVEP618 models only)

- Make sure all accessories are removed from the oven including shelves, trays and side racks.

- Switch on the appliance by pressing **ON/OFF**.
- Select the pyrolytic cleaning function and press **OK**.
- Press the **^** or **v** symbols to choose between "1hrs 30min" (light clean) or "2hrs 30min" (normal clean) for the appropriate level of cleaning.
- Press the "Pyro Accept" button to commence the cleaning process.
- The oven will begin heating and the "Remaining time" will be displayed.
- The pyrolytic cleaning function can be stopped at any time during the cycle by pressing the **ON/OFF**.

*NOTE: The "Remaining time" does not include cool-down time for the oven.*

#### During Pyrolytic cleaning

When the temperature in the oven approaches 300 °C, the door will automatically lock and a padlock symbol will appear on the display.

#### After Pyrolytic cleaning

The door will only unlock when the oven has cooled to a safe temperature. Turning the function off will not unlock the door.

After cool-down, wipe the ash out of the oven with a soft damp cloth and warm water. To restore the enamel shine to more difficult areas, use a damp cloth with vinegar and detergent.



### CAUTION

Do not turn off the mains power supply to the oven during the pyrolytic cleaning cycle. This could damage the appliance.

#### Cleaning the cavity well

The cleaning procedure removes limestone residue from the cavity well after cooking with steam.



### WARNING

Perform the cleaning procedure at least every 5 EasyBake + Steam cooking cycles.

1. Mix 150ml of tap water with 100ml of white vinegar and put the mix in the cavity well.
2. Let the water and vinegar mix dissolve the limestone residue at the ambient temperature for 45 minutes.
3. Remove the water and vinegar mix with a soft cloth and clean the cavity with warm water and a soft cloth.

#### Cleaning steam parts (WVEP618 model only)

After some time, the water tank can accumulate mineral deposits. To prevent this from occurring, empty the water tank after each steam cooking session and clean the water tank every two to three months using the following process.





## IMPORTANT

During the cleaning procedure, some water can drip from the steam outlet onto the cavity of the oven. Put a dripping pan on the shelf level directly below the steam inlet to prevent water from falling onto the bottom of the oven cavity.

### Cleaning procedure

1. With the oven turned off, fill the water tank with a cleaning solution of 850mL water and 5g citric acid. Leave the cleaning solution in the water tank for approximately 60 minutes.
2. Turn on the oven and set the oven function to 'Steam cooking'. Set the temperature to 230°C. After 25 minutes, turn off the oven and let it cool for 15 minutes.
3. Again, turn on the oven and set the oven function to 'Steam cooking'. Set the temperature to 180°C. After 10 minutes, turn off the oven and let it cool for 15 minutes.
4. Insert the supplied drain pipe and empty the tank of the remaining cleaning solution. When the tank is empty, remove the drain pipe.
5. To flush the water tank, refill the water tank with 850mL of fresh water and empty via the drain pipe.
6. Remove the drain pipe again and clean it by hand in warm water with soap.
7. To prevent the build up of calcium deposits it is recommended to use this procedure every 2-3 months.

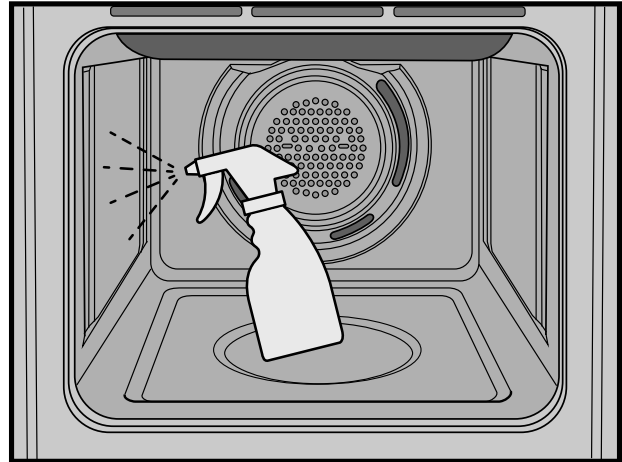

### Steam Assisted Cleaning function (WVE617 model only)

This function assists in the removal of food residue from inside the oven. This method is effective in removing light soiling only. It is not effective in removing stubborn baked-on stains. This function can only be used when the oven is cold.

#### Procedure for cleaning

1. Remove all shelves, dishes and side racks.
2. Make a solution of water (85%), white vinegar (10%), and dish washing detergent (5%) and spray liberally on to door, side walls and back wall of oven cavity.
3. Pour 40ml of water into the cavity base well.
4. Close the door. Set the function to Steam Assist Clean and set the temperature to 120°C.
5. Turn oven OFF after 18 minutes.
6. Allow to cool to a safe level before wiping surface with a wet cloth.

## USING YOUR COOKTOP



### CAUTION

The ceramic cooktop is made from ceramic glass, a tough durable material that withstands heating and cooling without breaking. However, it must be remembered that as it is glass, it may break. Treat it accordingly! Should you have any questions about the glass in your new appliance, please contact the Customer Care Centre. See back page for contact details.

The heating elements are concealed under the smooth glass surface which has a pattern to show the location of the elements. The glass will retain heat for a period of time after the appliance has been turned off. This is indicated by a "HOT SURFACE" warning light. It will remain on whenever the glass surface exceeds 60°C.

### Utensils

- Use pans with smooth, clean and dry bottoms to avoid scratching or burning residue into the glass.
- Ensure the pan bottom is the same size as the working element.
- We do not recommend ceramic glass pans because they do not conduct heat well. Stainless steel or enamelled saucepans are best.
- Do not use pans with copper or aluminium bottoms because they can leave traces which are difficult to remove from the glass.
- If buying new utensils, select enamelled steel pans with 2-3mm thick bottoms or stainless steel pans with sandwich bottoms 4-6mm thick. The pan bottom should be flat, or preferably, slightly concave at room temperature so that it lies flat on the glass surface when hot.

### Cooking Do's and Don'ts

- Do use the stored heat in the hotplate by turning the control off before the final few minutes of cooking.
- Do not place heat resistant mats, wire mats or aluminium foil under pots and pans.
- Do not allow pots and pans to boil dry, as damage to both pan and hotplate may result.
- Do not use round bottom woks, wok stands or similar utensils which could lead to overheating of the hotplates and possible damage to the cooking surface.
- Do not slide pans across the surface of the ceramic glass cooktop, it could result in scratching of the surface.
- Do not use the cooktop as extra bench space or as a cutting board.
- Do not allow children on or near the cooktop at any time.

### Cleaning your ceramic hotplate

1. Remove all spilt food and fat with a razor blade scraper (supplied with the unit) while the ceramic glass is still warm, but not hot. Wipe clean with dishwashing detergent on a damp cloth.
2. If aluminium foil, plastic items or high sugar content liquids/foods are allowed to melt on the ceramic glass, these should be removed immediately with a scraper before the surface has cooled down, otherwise pitting of the surface can occur.

*NOTE: Items with high sugar content not only include jam and fruit but also vegetables such as peas, tomatoes and carrots.*

3. When the ceramic glass is cool, apply a suitable cleaner (supplied with the unit).
4. It is important to follow the cleaner manufacturer's instructions. Remove any cleaning residue from the surface as staining of the cooktop may occur.
5. Do not use abrasive sponges or scourers, oven sprays or stain removers as they may scratch the cooktop.
6. Any pitting, staining, scratches or other surface deterioration is excluded from the warranty.
7. All stains/water marks can be removed by vigorous cleaning, using the supplied ceramic cleaner.

### Cooking hints

Bringing liquids to the boil	Use a high setting.
	Before the liquid begins to boil, turn to a lower setting. This will stop the liquid from boiling over.
Using retained heat	Cooking areas will stay hot after they are turned off. Turn the cooking area off before cooking is finished and use the retained heat to finish cooking.
Turning to higher settings	If the pot does not have a lid, use a higher setting.
Turning to lower settings	If the pot has a lid, then use a higher setting. Use a lower setting for foods which will easily burn e.g. milk, white sauce.
Cooking too fast	If food is cooking too fast, take the pot off the cooktop. Turn the knob to a lower setting. Let the cooking area cool down and replace the pot.

# TROUBLESHOOTING

## Cooktop

PROBLEM	POSSIBLE CAUSE	SOLUTION
Heating elements not working	<ul style="list-style-type: none"> <li>Power not switched on</li> <li>Controls incorrectly set</li> <li>Household fuse blown</li> </ul>	<ul style="list-style-type: none"> <li>Check cooktop is plugged in and power is on</li> <li>Check correct knob turned for element</li> <li>Replace household fuse. If the fuse continues to blow, contact the Service Centre</li> </ul>
Benchtop becoming too hot and/or beginning to discolour	<ul style="list-style-type: none"> <li>Wrong type of cooking pot</li> <li>Pot may overhang the cooktop</li> <li>Pot is too large</li> </ul>	<ul style="list-style-type: none"> <li>Make sure bases are not concave</li> <li>Place pot on centre of element so that it does not overhang</li> <li>Use a smaller pot</li> </ul>
Food taking too long to cook	<ul style="list-style-type: none"> <li>Pot base is not flat</li> <li>Pot may be off centre</li> <li>Need to use a larger element</li> <li>Using a round based wok</li> <li>Controls are incorrectly set</li> </ul>	<ul style="list-style-type: none"> <li>Make sure pot base is flat or slightly convex</li> <li>Centre pot over element making sure it does not overhang the cooktop</li> <li>Move pot to a larger element</li> <li>Use a flat based wok on electric cooktops</li> <li>Check controls are set correctly and increase if necessary</li> </ul>
Cannot simmer food	<ul style="list-style-type: none"> <li>Control set too high</li> <li>Element too large</li> </ul>	<ul style="list-style-type: none"> <li>Turn control to lower setting</li> <li>Use a smaller element</li> </ul>
Elements giving off smoke or odours when first used	<ul style="list-style-type: none"> <li>Protective oils being removed in first cooking</li> </ul>	<ul style="list-style-type: none"> <li>Do not worry, this is normal</li> </ul>
Glass surface becomes milky white when pot is removed	<ul style="list-style-type: none"> <li>Base of pot is concave</li> </ul>	<ul style="list-style-type: none"> <li>Use a flat based pot</li> </ul>

## Faults

If there is a problem with the oven and/or grill, please:

- Check the points listed below before calling for service. It may be possible to avoid a call by fixing the problem yourself – and so continue cooking.
- For cooking problems refer to “Dealing with cooking problems”.

*NOTE: We may charge for service even in the guarantee period if your problem is due to the causes listed below.*

## Data Plate

When you need information, service or spare parts please be prepared to tell us the:

- Model number
- Serial number

These are shown on the data plate. The data plate is visible when the oven or grill door is open.

If you need more information, please contact the Customer Care Centre. See back page for contact details.

## TROUBLESHOOTING (CONTINUED)

### Oven

PROBLEM	POSSIBLE CAUSE
Oven or grill not working	<ul style="list-style-type: none"> <li>• Time of day not set.</li> <li>• Power not turned on.</li> <li>• Controls are incorrectly set.</li> <li>• Oven is in 'Demo' mode, refer to Using your oven section.</li> <li>• Household fuse has blown or power supply is off.</li> </ul> <p><i>NOTE: If the household fuse continues to blow, call the Customer Care Centre.</i></p> <ul style="list-style-type: none"> <li>• Child-proof oven lock is activated. 'LOCKED' is displayed when control is touched. (Refer to Using your oven section)</li> </ul>
The oven seal is loose	<ul style="list-style-type: none"> <li>• The oven seal is only attached at each corner. It may seem like a loose fit but when the oven door is closed it will function correctly.</li> </ul>
Oven light not working	<ul style="list-style-type: none"> <li>• Light may be turned off at control panel.</li> <li>• Lamp blown or loose in socket.</li> <li>• Household fuse has blown.</li> </ul> <p><i>NOTE: If the household fuse continues to blow, call the Customer Care Centre.</i></p>
Oven not heating enough	<ul style="list-style-type: none"> <li>• Foil or trays on bottom of oven.</li> <li>• Timer is in "AUTO" mode. (Refer to timer operating instructions)</li> <li>• Household fuse has blown.</li> </ul> <p><i>NOTE: If the household fuse continues to blow, call the Customer Care Centre.</i></p>
Clock flashing on display	<ul style="list-style-type: none"> <li>• Reset time of day and any cooking functions you were using.</li> </ul>
Unit smoking when first used	<ul style="list-style-type: none"> <li>• Protective oils being removed.</li> </ul>
Condensation build up	<ul style="list-style-type: none"> <li>• Reduce the amount of water used in cooking. (Sometimes condensation is normal)</li> </ul>
Door cannot be replaced after removal	<ul style="list-style-type: none"> <li>• Stirrup not engaged properly.</li> </ul>
Functions and temperature appear on display but oven does not work	<ul style="list-style-type: none"> <li>• Oven is in 'Demo' mode, refer to Using your oven section.</li> </ul>
When the door is open the fan stops (underbench only)	<ul style="list-style-type: none"> <li>• This is a function of the power board to help reduce the blast of air when opening the door.</li> </ul>
When a non fan mode is selected the fan starts	<ul style="list-style-type: none"> <li>• Most oven modes have a fast heat up function that uses the fan, fan element and top (boost) elements. Auto fast heat up can be overridden by selecting a temperature of 120°C or less, allowing the function to start, then increasing the temperature to the desired level.</li> </ul>
The light stays on when the door is closed	<ul style="list-style-type: none"> <li>• An oven function has been selected.</li> <li>• The light has been turned on at the control panel.</li> </ul>
The light does not turn *ON* when the door is opened	<ul style="list-style-type: none"> <li>• Oven light may need replacing.</li> </ul>
Shelf or telescopic runner slides out when door is opened	<ul style="list-style-type: none"> <li>• Oven cavity is not level, you can perform a check using a level to verify this (refer to installation section). If not level refer to installer.</li> </ul>

*NOTE: Only authorised personnel should carry out servicing.*





**This document sets out the terms and conditions of the product warranties for Westinghouse Appliances. It is an important document. Please keep it with your proof of purchase documents in a safe place for future reference should there be a manufacturing defect in your Appliance. This warranty is in addition to other rights you may have under the Australian Consumer Law.**

**1. In this warranty:**

- (a) 'ACL' or 'Australian Consumer Law' means Schedule 2 to the Competition and Consumer Act 2010;
- (b) 'Appliance' means any Electrolux product purchased by you and accompanied by this document;
- (c) 'ASC' means Electrolux's authorised serviced centres;
- (d) 'Westinghouse' is the brand controlled by Electrolux Home Products Pty Ltd of 163 O'Riordan Street, Mascot NSW 2020, ABN 51 004 762 341 in respect of Appliances purchased in Australia and Electrolux (NZ) Limited (collectively "Electrolux") of 3-5 Niall Burgess Road, Mount Wellington, in respect of Appliances purchased in New Zealand;
- (e) 'Warranty Period' means the period specified in clause 3 of this warranty;
- (f) 'you' means the purchaser of the Appliance not having purchased the Appliance for re-sale, and 'your' has a corresponding meaning.

**2. Application:** This warranty only applies to new Appliances, purchased and used in Australia or New Zealand and is in addition to (and does not exclude, restrict, or modify in any way) other rights and remedies under a law to which the Appliances or services relate, including any non-excludable statutory guarantees in Australia and New Zealand.

**3. Warranty Period:** Subject to these terms and conditions, this warranty continues in Australia for a period of 24 months and in New Zealand for a period of 24 months, following the date of original purchase of the Appliance.

**4. Repair or replace warranty:** During the Warranty Period, Electrolux or its ASC will, at no extra charge if your Appliance is readily accessible for service, without special equipment and subject to these terms and conditions, repair or replace any parts which it considers to be defective. Electrolux may, in its absolute discretion, choose whether the remedy offered for a valid warranty claim is repair or replacement. Electrolux or its ASC may use refurbished parts to repair your Appliance. You agree that any replaced Appliances or parts become the property of Electrolux.

**5. Travel and transportation costs:** Subject to clause 7, Electrolux will bear the reasonable cost of transportation, travel and delivery of the Appliance to and from Electrolux or its ASC. Travel and transportation will be arranged by Electrolux as part of any valid warranty claim.

**6. Proof of purchase** is required before you can make a claim under this warranty.

**7. Exclusions:** You may not make a claim under this warranty unless the defect claimed is due to faulty or defective parts or workmanship. This warranty does not cover:

- (a) light globes, batteries, filters or similar perishable parts;
- (b) parts and Appliances not supplied by Electrolux;
- (c) cosmetic damage which does not affect the operation of the Appliance;

- (d) damage to the Appliance caused by:
  - (i) negligence or accident;
  - (ii) misuse or abuse, including failure to properly maintain or service;
  - (iii) improper, negligent or faulty servicing or repair works done by anyone other than an Electrolux authorised repairer or ASC;
  - (iv) normal wear and tear;
  - (v) power surges, electrical storm damage or incorrect power supply;
  - (vi) incomplete or improper installation;
  - (vii) incorrect, improper or inappropriate operation;
  - (viii) insect or vermin infestation;
  - (ix) failure to comply with any additional instructions supplied with the Appliance;

In addition, Electrolux is not liable under this warranty if:

- (a) the Appliance has been, or Electrolux reasonably believes that the Appliance has been, used for purposes other than those for which the Appliance was intended, including where the Appliance has been used for any non-domestic purpose;
- (b) the Appliance is modified without authority from Electrolux in writing;
- (c) the Appliance's serial number or warranty seal has been removed or defaced

**8. How to claim under this warranty:** To enquire about claiming under this warranty, please follow these steps:

- (a) carefully check the operating instructions, user manual and the terms of this warranty;
- (b) have the model and serial number of the Appliance available;
- (c) have the proof of purchase (e.g. an invoice) available;
- (d) telephone the numbers shown below.

**9. Australia:** For Appliances and services provided by Electrolux in Australia: Electrolux goods come with guarantees that cannot be excluded under the Australian Consumer Law. You are entitled to a replacement or refund for a major failure and for compensation for any other reasonably foreseeable loss or damage. You are also entitled to have the Appliance repaired or replaced if the Appliance fails to be of acceptable quality and the failure does not amount to a major failure. 'Acceptable quality' and 'major failure' have the same meaning as referred to in the ACL.

**10. New Zealand:** For Appliances and services provided by Electrolux in New Zealand, the Appliances come with a guarantee by Electrolux pursuant to the provisions of the Consumer Guarantees Act, the Sale of Goods Act and the Fair Trading Act. Where the Appliance was purchased in New Zealand for commercial purposes the Consumer Guarantee Act does not apply.

**11. Confidentiality:** You accept that if you make a warranty claim, Electrolux and its agents including ASC may exchange information in relation to you to enable Electrolux to meet its obligations under this warranty.

**Important Notice**

Before calling for service, please ensure that the steps listed in clause 8 above have been followed.

<b>AUSTRALIA</b>	<b>FOR SERVICE</b> or to find the address of your nearest authorised service centre in Australia <b>PLEASE CALL 13 13 49</b> <small>For the cost of a local call</small>	<b>FOR SPARE PARTS</b> or to find the address of your nearest spare parts centre in Australia <b>PLEASE CALL 13 13 50</b> <small>For the cost of a local call</small>
<b>NEW ZEALAND</b>	<b>FOR SERVICE</b> or to find the address of your nearest authorised service centre in New Zealand <b>PLEASE CALL 0800 10 66 10</b>	<b>FOR SPARE PARTS</b> or to find the address of your nearest spare parts centre in New Zealand <b>PLEASE CALL 0800 10 66 20</b>

**For more information on all Westinghouse appliances, or for dimension and installation information, call into your retailer, phone or email our customer care team or visit our website:**

**AUSTRALIA**

phone: 13 13 49

email: [customercare@electrolux.com.au](mailto:customercare@electrolux.com.au)

web: [westinghouse.com.au](http://westinghouse.com.au)

**NEW ZEALAND**

phone: 0800 10 66 10

email: [customercare@electrolux.co.nz](mailto:customercare@electrolux.co.nz)

web: [westinghouse.co.nz](http://westinghouse.co.nz)

 and WESTINGHOUSE are trademarks of Westinghouse Electric Corporation. Used under license by Electrolux Home Products Pty Ltd. All Rights Reserved.

P/No: A18857101

© 2019 Electrolux Home Products Pty Ltd.  
ABN 51 004 762 341  
WMAN\_EBIC\_Dec19