

the Smart Oven™ Air Fry

Instruction Book - Suits all BOV860 models



Breville®



Contents

2	Breville recommends safety first	
6	Components	
8	Before first use	
10	Functions	
	- OPERATING YOUR BREVILLE OVEN	
	- AUTO EJECT RACK	11
	- GRILL	11
	- TOAST	11
	- CRUMPET	12
	- BAKE	13
	- PIZZA	15
	- WARM	17
	- AIR FRY	17
	- SLOW COOK	18
	- REPLACING THE OVEN LIGHT	19
21	Care & Cleaning	
22	Troubleshooting	

BREVILLE RECOMMENDS SAFETY FIRST

At Breville we are very safety conscious. We design and manufacture consumer products with the safety of you, our valued customer, foremost in mind. In addition we ask that you exercise a degree of care when using any electrical appliance and adhere to the following precautions.

IMPORTANT SAFEGUARDS

READ ALL INSTRUCTIONS BEFORE USE AND SAVE FOR FUTURE REFERENCE

When using electrical appliances, basic safety precautions should always be followed including:

- Remove and safely discard any packing materials and promotional labels before using the oven for the first time.
- To avoid choking hazard for young children, remove and safely dispose the protective cover fitted on the power plug.
- Do not use the appliance near the edge of a bench top or table. Ensure the surface is stable, level, heat-resistant and clean.

- Do not use on a cloth-covered surface, near curtains or other flammable materials.
- A fire may occur if the oven is covered or touches flammable material, including curtains, draperies, walls, and the like, when in operation.
- Do not use the appliance on (or close to) a hot gas or electric burner, or where it could touch a heated oven or surface.
- Do not let the power cord hang over the edge of a table or counter, or touch hot surfaces.
- To avoid electric shock, do not immerse the cord or plug in water (or other liquids).
- When operating the oven, keep a minimum distance of 10cm of space on both sides of the appliance and 15cm above.
- The temperature of accessible surfaces may be high when the appliance is operating. Do not touch hot surfaces. To avoid burns, use extreme caution when removing pans, dishes and accessories such as the included grilling rack and baking pan, that contain hot oil or other hot liquids.
- Do not lay cooking utensils, baking pans or dishes on the glass door.
- Do not leave the door standing open for extended periods of time.
- Do not store any item on top of the oven when in operation except those described on page 21 of this book.
- Do not place cardboard, plastic, paper, or other flammable materials in the oven.
- Do not cover crumb tray or any part of the oven with metal foil. This will cause overheating of the oven.
- Caution should be exercised when using pans and dishes constructed of materials other than metal. Ensure pans and dishes are oven safe before using in the oven.
- Caution should be exercised when using lids in the oven, as pressure build up in a covered pan or dish may cause hot ingredients to expel or the dish to crack. Do not place sealed or airtight containers in the oven.
- Oversized foods and metal utensils must not be inserted in the oven as they may create fire or risk of electric shock.
- The use of accessories and attachments not recommended or supplied with this oven may cause injuries.

- This appliance is for household use only. Do not use in any type of moving vehicles. Do not use the appliance outdoors, or for anything other than its intended use. **Misuse can cause injury.**
- If the appliance is to be: left unattended, cleaned, moved, assembled or stored, always switch the unit off and unplug the cord from the power outlet and allow to cool completely.
- Do not clean with metal scouring pads. Pieces can break off the pad and touch electrical parts, creating a risk of electric shock.
- This appliance is not intended for use by persons (including children) with reduced physical, sensory or mental capabilities, or lack of experience and knowledge, unless they have been given supervision or instruction concerning the use of the appliance by a person responsible for their safety.
- Children should be supervised to ensure that they do not play with the appliance.
- It is recommended to regularly inspect the appliance and power cord. Do not use the appliance if there is damage to

the power cord or plug, or after the appliance malfunctions or has been damaged in any way. Immediately stop use and call Breville Customer Service.

- The appliance is not intended to be operated by means of external timer or separate remote-control system.

SPECIFIC INSTRUCTIONS FOR BOV860

- We recommend the oven is operated on a dedicated circuit separated from other appliances. Consult a licensed and qualified electrician if you are unsure.
- To turn off the oven, press the START/CANCEL button on the control panel. The oven is off when the button back-lights turn off.
- Regularly clean the crumb tray. To clean the crumb tray:
 - Turn OFF the oven,
 - Allow the oven to cool completely and then remove the power cord from the power outlet.
 - Remove the crumb tray and clean with warm soapy water.
 - Dry the tray completely before inserting it securely back in place.



WARNING

To reduce the risk of FIRE, ELECTRIC SHOCK, EXPOSURE TO EXCESSIVE UV RADIATION, OR INJURY TO PERSONS:

- Always unplug the oven and let all parts (including the bulb housing, glass cover and enclosure) cool completely before replacing bulb.
- Only use a 25 Watt, 220–240V, G9 type oven bulb.
- Always use a soft cloth when handling the bulb and do not directly touch the surface as oil from your skin can damage the bulb.
- Do not look directly at a glowing bulb.
- Do not remain in the light if skin feels warm.
- Keep bulb away from materials that may burn.
- The bulb gets hot quickly. Only ever use the light button to turn on the light.
- Do not operate the light if the bulb housing, glass cover, UV filter or enclosure is missing or damaged.

BREVILLE ASSIST® PLUG

Your Breville appliance comes with a unique Assist® Plug, conveniently designed with a finger hole to ease removal from the power outlet.

**FOR HOUSEHOLD USE ONLY
SAVE THESE INSTRUCTIONS**



Components

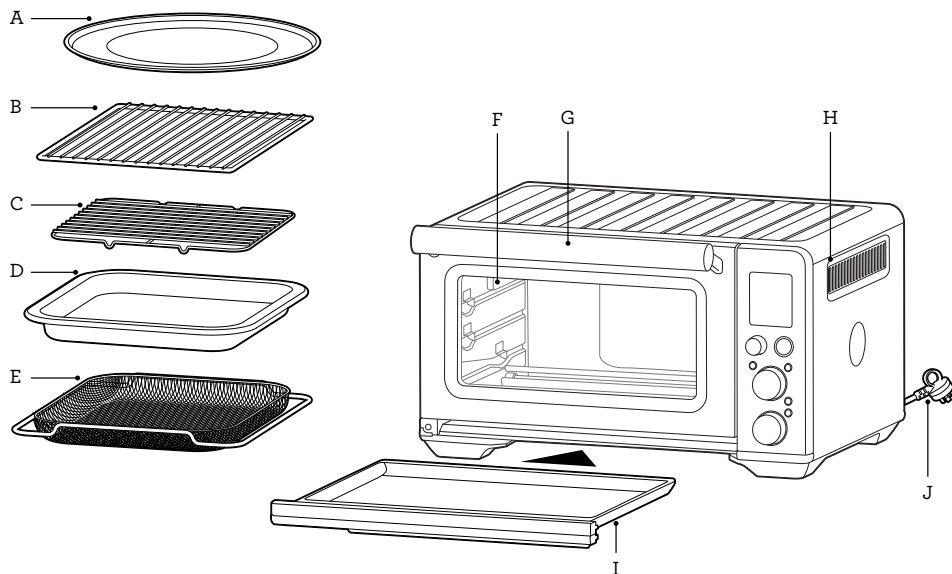

A. 30 cm non-stick pizza pan

B. Wire rack

C. Grilling rack

D. 28 x 33.5 cm enamel roasting pan

E. Air fry basket

F. Oven light

G. Door handle

H. Ventilation slots

I. Crumb tray

J. Breville Assist® Plug

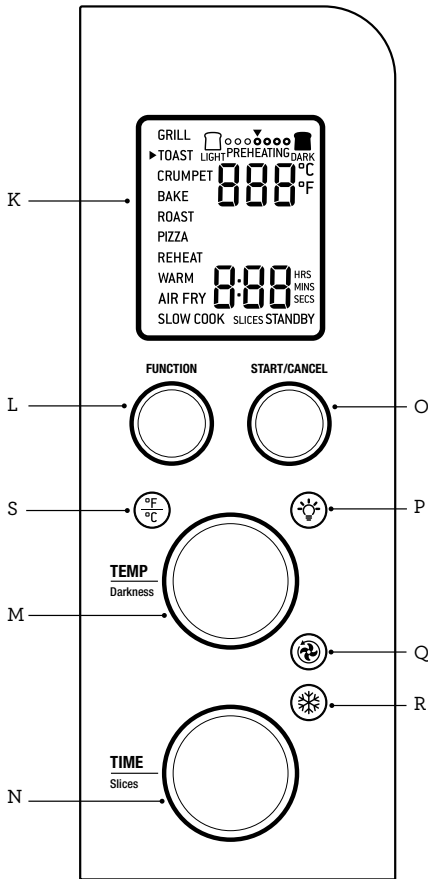

- K. LCD screen
- L. FUNCTION dial
- M. TEMPERATURE dial/toast and crumpet darkness control
- N. TIME dial/toast and crumpet selection
- O. START/CANCEL button
- P. OVEN LIGHT button
- Q. CONVECTION button
- R. FROZEN button
- S. TEMPERATURE CONVERSION button and volume adjustment button

Accessories sold separately:

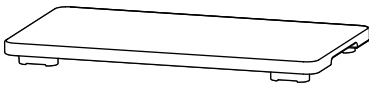

Bamboo Cutting Board

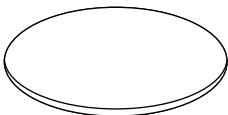

Pizza Stone

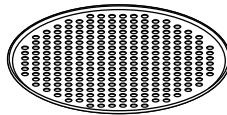

Pizza Crisper Pan



Functions

PREPARING THE OVEN

Before first use, please run the oven empty for 20 minutes to remove protective substances from the heating elements. Ensure the area is well ventilated as the oven may emit vapors. These vapors are safe and are not detrimental to the performance of the oven.

1. Remove and safely discard any packing material, promotional labels and tape from the oven.
2. Remove the crumb tray, wire racks, grilling rack, roasting pan, air fry basket and pizza pan from the polyfoam packaging. Wash them with a soft sponge in warm, soapy water then rinse and dry thoroughly.
3. Wipe the interior of the oven with a soft, damp sponge. Dry thoroughly.
4. Place the oven on a flat, dry surface. Ensure there is a minimum distance of 10cm of space on both sides of the appliance and 15cm above.
5. Insert the crumb tray into the oven.
6. Unwind the power cord completely and insert the power plug into a grounded power outlet.
7. The oven alert will sound and the LCD screen will illuminate. The function options will appear with an indicator on the GRILL setting.
8. Turn the START/CANCEL dial to the right until the indicator reaches the PIZZA function.



9. Press the START/CANCEL button. The button backlight will illuminate red, the LCD screen will illuminate orange and the oven alert will sound.
10. The LCD screen will indicate a blinking 'PREHEATING'. Once the oven has completed the preheating cycle, an alert will sound.
11. The timer will be displayed and automatically begin to count down.
12. At the end of the cooking cycle, the oven alert will sound, the START/CANCEL button backlight will go out and the LCD screen will illuminate blue.
13. The oven is now ready to use.

ELEMENT IQ™

The Breville Smart Oven™ Air Fry features Element IQ™, a cooking technology that creates the ideal environment for the food you're cooking. It steers power where and when it's needed and creates the right kind of heat, whether even or intense.

Each of the oven's functions is preset with our recommended heating element configurations and temperatures, that are based on recipes and testing. However, we suggest experimenting with these depending on the recipe, amount of food and your personal taste.

Your customised setting will remain in the memory of the oven until changed or the oven is unplugged from the power outlet.

OVEN FUNCTIONS OVERVIEW

FUNCTION	SUGGESTED RACK POSITION	OPTIONAL SETTINGS	PRESETS	PREHEAT	RANGE
GRILL	Top		HI 10 MINS	No	HI-MED-LO Up to 20 MINS
TOAST	Middle	FROZEN	Darkness 4 Slices 4	No	Darkness 1-7 Slices 1-6
CRUMPET	Top	FROZEN	Darkness 4 Slices 4	No	Darkness 1-7 Slices 1-6
BAKE	Bottom	CONVECTION TEMPERATURE CONVERSION	160°C CONVECTION 30 MINS	Yes	50°C-230°C Up to 2:00 HRS
ROAST	Bottom	CONVECTION TEMPERATURE CONVERSION	175°C CONVECTION 1:00 HRS	Yes	50°C-230°C Up to 2:00 HRS
PIZZA	Middle	CONVECTION TEMPERATURE CONVERSION FROZEN	210°C CONVECTION FROZEN 20 MINS	Yes	50°C-230°C Up to 2:00 HR
REHEAT	Bottom	CONVECTION TEMPERATURE CONVERSION	165°C CONVECTION 15 MINS	Yes	50°C-230°C Up to 2:00 HRS
WARM	Bottom	CONVECTION TEMPERATURE CONVERSION	70°C KEEP WARM 1:00 HRS	No	50°C-230°C Up to 2:00 HRS
AIR FRY	Top	SUPER CONVECTION TEMPERATURE CONVERSION FROZEN	220°C 15 MIN SUPER CONVECTION	No	50°C-230°C Up to 2:00 HRS
SLOW COOK	Bottom	CONVECTION	HI CONVECTION 4:00 HRS	Yes	HI-LO Up to 10:00 HRS



Functions

OPERATING YOUR BREVILLE OVEN

1. Position the wire rack so the spokes face upward and insert it into the desired rack position. The rack positions are conveniently printed on the oven door window.

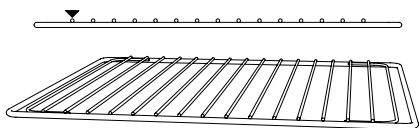

2. Turn the FUNCTION dial until the indicator on the LCD screen reaches the desired setting. .
3. The top figure on the LCD screen indicates the preset cooking temperature for the selected setting. For the TOAST and CRUMPET settings it indicates the darkness level. Turn the TEMPERATURE dial to the left to reduce the temperature or to the right to increase the temperature.

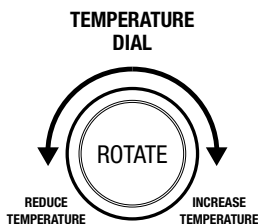

4. The bottom figure on the LCD screen indicates the preset cooking time for the selected setting. For the TOAST and CRUMPET settings it indicates the number of slices. Turn the TIME dial to the left to reduce the cooking time or to the right to increase the cooking time.

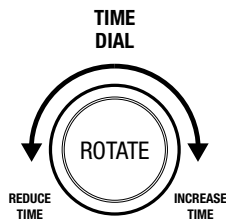

5. For settings without a preheat cycle (TOAST, CRUMPET, GRILL, WARM), place the food directly on the wire rack or on the included air fry basket, pizza pan, grilling rack and/or roasting pan. Ensure the food is centered in the oven for the most even cooking.
 - a) Close the oven door.
 - b) Press the START/CANCEL button. The button backlight will illuminate red, the oven alert will sound, and the LCD screen will illuminate orange.
 - c) The timer will be displayed and begin to count down. The cooking temperature and time can be adjusted during the cooking cycle.
6. For settings that feature a preheat cycle (BAKE, ROAST, PIZZA, AIR FRY, SLOW COOK), press the START/CANCEL button before placing food in the oven. The button backlight will illuminate red, the oven alert will sound and the LCD screen will indicate a blinking 'PREHEATING' while the oven is heating up.
 - a) When the oven is ready for use, the blinking 'PREHEATING' will go out, the oven alert will sound and the timer will start counting down. Place the food directly on the wire rack, or on the included air fry basket, pizza pan, grilling rack and/or roasting pan. Ensure the food is centered in the oven for the most even cooking.
 - b) Close the oven door.
 - c) The timer will continue to count down. The cooking temperature and time can be adjusted during the cooking cycle.
7. At the end of the cooking cycle, the oven alert will sound, the START/CANCEL button backlight will go out and the LCD screen will illuminate blue.



NOTE

The cooking cycle can be stopped at any time by pressing the START/CANCEL button. This will cancel the cycle and the button backlight will illuminate blue.



NOTE

Press the CONVECTION button to choose between no convection, convection and super convection. Convection and super convection may adjust the temperature to compensate for the faster air flow. Super convection will deliver a crispier food result.

MAGNETIC AUTO-EJECT RACK

When the wire rack is inserted into the middle rack position, it will automatically eject halfway out of the oven when the door is opened so you can easily remove your food.

Always open the door slowly when the wire rack is in this position to prevent the rack from ejecting too quickly.

GRILL FUNCTION

The GRILL function is ideal for cooking open-faced sandwiches, thin cuts of meat, poultry and fish, sausages and vegetables. Grilling can also be used to brown the tops of casseroles, gratins and desserts.

1. Insert the wire rack, with the spokes facing upward, into the top rack height position.
2. Insert the included grilling rack into the roasting pan. Place food on the assembled grilling rack or in an oven-proof dish, then place on the center of the wire rack so air flows around the sides of the food.
3. Close the oven door.
4. Turn the FUNCTION dial until the indicator on the LCD screen reaches the GRILL function. The top figure on the LCD screen indicates the preset power level 'HI', while the bottom figure indicates the preset time of '10 MINS'.



5. The grilling power level and time can be adjusted before or during the grilling cycle.
 - a) The grilling power level is displayed as the top figure on the LCD screen. Turn the TEMPERATURE dial to adjust grilling to one of three power levels: 'HI', 'MED' and 'LO'.
 - b) The grilling time is displayed as the bottom figure on the LCD screen. Turn the TIME dial to adjust the time up to 20 minutes.
6. Press the START/CANCEL button to activate the GRILL function. The button backlight will illuminate red, the oven alert will sound and the LCD screen will illuminate orange.
7. The timer will be displayed and automatically begin to count down. The power level and time can be adjusted during the grilling cycle by turning the corresponding TEMPERATURE and TIME dial. The cycle can be stopped at any time by pressing the START/CANCEL button.
8. At the end of the grill cycle, the oven alert will sound. The START/CANCEL button backlight will go out and the LCD screen will illuminate blue.

TOAST FUNCTION

The TOAST function browns and crisps the outside of your bread while keeping the inside soft and moist. This function is also ideal for English muffins and frozen waffles.

1. Insert the wire rack, with the spokes facing upward, into the middle rack height position.

- Position bread slices as close to the center of the wire rack as possible for optimum toasting results.
- Close the oven door.
- Turn the FUNCTION dial until the indicator on the LCD screen reaches the TOAST function. The top figure on the LCD screen indicates the preset darkness setting '4', while the bottom figure indicates the preset number of slices '4'.



- The darkness setting and number of slices can be adjusted before or during the toasting cycle.
 - The darkness setting is indicated by the row of circles at the top of the LCD screen. Turn the TEMPERATURE dial to the left to reduce the darkness setting, or to the right to increase it. The triangle above the circles will move according to the selected setting.

As general guide:

Desired toast colour	Setting
Light	1 or 2
Medium	3, 4 or 5
Dark	6 or 7

- The number of slices is displayed as the bottom figure on the LCD screen. Turn the TIME dial to the left to reduce the number of slices, or to the right to increase it. The number of slices ranges from '1' to '6'.
- Press the START/CANCEL button to start the TOAST function. The button backlight will illuminate red, the oven alert will sound, and the LCD screen will illuminate orange.

- The timer will be displayed and automatically begin to count down. The time can be adjusted during the toasting cycle by turning the TIME dial. The cycle can be stopped at any time by pressing the START/CANCEL button.

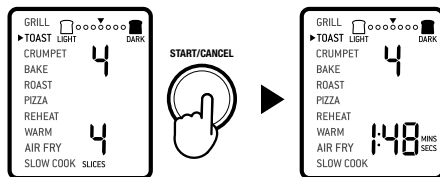

- At the end of the TOAST cycle, the oven alert will sound. The START/CANCEL button backlight will go out and the LCD screen will illuminate blue.

NOTE

The cooking time is dependent on a number of variables including the temperature in the oven, so the time may vary, even with the same colour and slices settings. This is in order to achieve consistent results.

CRUMPET FUNCTION

The CRUMPET function directs more heat on the top elements in order to brown and crisp one side more than the other.

The top of the crumpet can be placed facing up or down, depending on what side you prefer to be more crisped.

This function is also ideal for toasting bagels or thick sliced specialty breads which require one side to be toasted more than the other.

- Insert the wire rack, with the spokes facing upward, into the top rack height position.
- If toasting 1-3 crumpets, centre on the wire rack. If toasting 4-6 crumpets, evenly space them with 2-3 crumpets at the front of the wire rack and 2-3 crumpets at the back of the rack.
- Close the oven door.
- Turn the FUNCTION dial until the indicator on the LCD screen reaches the CRUMPET function. The top figure on the LCD screen

indicates the preset darkness setting '4', while the bottom figure indicates the preset number of crumpets '4'.

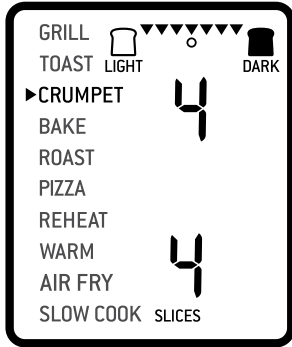

5. The darkness setting and number of crumpets can be adjusted before or during the toasting cycle.
 - a) The darkness setting is indicated by the row of triangles at the top of the LCD screen. Turn the TEMPERATURE dial to the left to reduce the darkness setting, or to the right to increase it. The circle below the triangles will move according to the selected setting.

As general guide:

Desired crumpet colour	Setting
Light	1 or 2
Medium	3, 4 or 5
Dark	6 or 7

- b) The number of crumpets is displayed as the bottom figure on the LCD screen. Turn the TIME dial to the left to reduce the number of crumpets, or to the right to increase it. The number of crumpets ranges from '1' to '6'.
6. Press the START/CANCEL button to start the CRUMPET function. The button backlight will illuminate red, the oven alert will sound, and the LCD screen will illuminate orange.
7. The timer will be displayed and automatically begin to count down. The time can be adjusted during the crumpet cycle by turning the TIME dial. The cycle can be stopped at any time by pressing the START/CANCEL button.

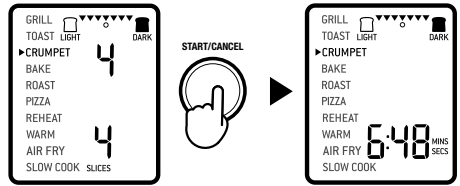

8. At the end of the CRUMPET cycle, the oven alert will sound. The START/CANCEL button backlight will go out and the LCD screen will illuminate blue.

NOTE

If you like your crumpets equally crisp on both the top and bottom, we recommend using the TOAST function.

BAKE FUNCTION

The BAKE function uses the Element IQ system to cook food evenly throughout. This function is ideal for baking cakes, muffins, brownies and pastries. The BAKE function is also ideal for cooking pre-packaged frozen meals such as lasagna and pot pies.

1. Insert the wire rack, with the spokes facing upward, into the bottom rack height position. Note that some baked goods, such as brownies or pastries, may be more suited to the middle rack height position.
2. Close the oven door.
3. Turn the FUNCTION dial until the indicator on the LCD screen reaches the BAKE function. The top figure on the LCD screen indicates the preset BAKE temperature of '160°C', while the bottom figure indicates the preset time of ':30 MINS'. The preset CONVECTION setting will also be displayed.



4. The baking temperature, time and convection settings can be adjusted before or during the baking cycle.

- a) The baking temperature is displayed as the top figure on the LCD screen. Turn the TEMPERATURE dial to adjust the baking temperature from 50°C to a maximum of 230°C.
 - b) The baking time is displayed as the bottom figure on the LCD screen. Turn the TIME dial to adjust the time up to 2 hours.
5. Press the START/CANCEL button to activate the BAKE function. The button backlight will illuminate red, the oven alert will sound and the LCD screen will illuminate orange. The LCD screen will indicate a blinking 'PREHEATING'.
6. Once the oven has finished preheating, an alert will sound and food can be inserted into the oven.
7. Place food, positioned on the included roasting pan or other oven-proof dish, on the center of the wire rack so air will flow around all sides of the food. Close the oven door.
8. After the PREHEATING alert has sounded, the timer will automatically begin to count down. The cycle can be stopped at any time by pressing the START/CANCEL button.

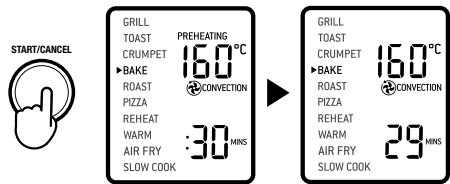

9. At the end of the BAKE cycle, the oven alert will sound. The START/CANCEL button backlight will go out and the LCD screen will illuminate blue.

ROAST FUNCTION

The ROAST function is ideal for cooking a variety of meats and poultry. Food will be tender and juicy on the inside and roasted to perfection on the outside.

1. Insert the wire rack, with the spokes facing upward, into the bottom rack height position.
2. Close the oven door.
3. Turn the FUNCTION dial until the indicator on the LCD screen reaches the ROAST function. The top figure on the LCD screen indicates the preset ROAST temperature of 175°C, while the bottom figure indicates the preset time of 1:00HR/MIN'. The preset CONVECTION setting will also be displayed.



4. The roasting temperature, time and convection settings can be adjusted before or during the roasting cycle.
- a) The roasting temperature is displayed as the top figure on the LCD screen. Turn the TEMPERATURE dial to adjust the roasting temperature from 50°C to a maximum of 230°C.

- b) The roasting temperature is displayed as the top figure on the LCD screen. Turn the TIME dial to adjust the time up to 2 hours.
5. Press the START/CANCEL button to activate the ROAST function. The button backlight will illuminate red, the oven alert will sound and the LCD screen will illuminate orange. The LCD screen will indicate a blinking 'PREHEATING'.
6. Once the oven has finished preheating, an alert will sound and food can be inserted into the oven.
7. Place food, positioned on the included roasting pan or other oven-proof dish, on the center of the wire rack so air will flow around all sides of the food. Close the oven door.
8. After the PREHEATING alert has sounded, the timer will automatically begin to count down. The cycle can be stopped at any time by pressing the START/CANCEL button.

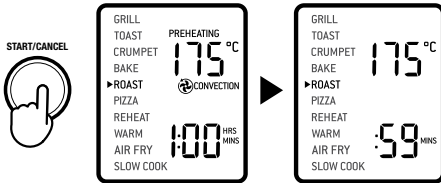

9. At the end of the ROAST cycle, the oven alert will sound. The START/CANCEL button backlight will go out and the LCD screen will illuminate blue.

PIZZA FUNCTION

The PIZZA function melts and browns cheese and toppings, while crisping up the pizza crust.

1. Insert the wire rack, with the spokes facing upward, into the middle rack height position.
2. Close the oven door.
3. Turn the FUNCTION dial until the indicator on the LCD screen reaches the PIZZA function. The top figure on the LCD screen indicates the preset PIZZA temperature of 210°C, while the bottom figure indicates the preset time of '20 MINS'. The preset CONVECTION and FROZEN settings will also be displayed.



4. The pizza temperature, time, convection, and frozen settings can be adjusted before or during the cycle.
 - a) The pizza temperature is displayed as the top figure on the LCD screen. Turn the TEMPERATURE dial to adjust the temperature from 50°C to a maximum of 230°C.
 - b) The cooking time is displayed as the bottom figure on the LCD screen. Turn the TIME dial to adjust the time up to 2 hours.
5. Press the START/CANCEL button to activate the PIZZA function. The button backlight will illuminate red, the oven alert will sound and the LCD screen will illuminate orange. The LCD screen will indicate a blinking 'PREHEATING'.
6. Once the oven has reached the set temperature, the temperature alert will sound.
7. Place food, positioned on the included pizza pan if using, on the center of the wire rack so air will flow around all sides of the food. Close the oven door.
8. After the PREHEATING alert has sounded, the timer will automatically begin to count down. The cycle can be stopped at any time by pressing the START/CANCEL button.

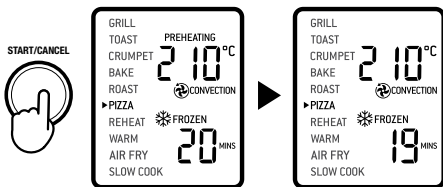

- At the end of the PIZZA cycle, the oven alert will sound. The START/CANCEL button backlight will go out and the LCD screen will illuminate blue.



NOTE

If using the included pizza pan, place it in the oven during the preheating cycle for the best result. Carefully place pizza on the heated pizza pan.

A note on pizza stones

When using a pizza stone, it is necessary to preheat the stone, without a pizza, for optimum results.

- Insert the wire rack, with the spokes facing upward, into the middle rack height position.
- Place pizza stone on the center of the wire rack so air will flow around all sides of the stone.
- Close the door and proceed according to PIZZA function instructions.

REHEAT FUNCTION

The REHEAT function is ideal for gently reheating leftovers without browning or drying them out.

- Insert the wire rack into a rack position that best suits the type of food you are reheating.
- Place food, positioned on the included roasting pan, pizza pan or other oven-proof dish, on the center of the wire rack so air will flow around all sides of the food.
- Close the oven door.

- Turn the FUNCTION dial until the indicator on the LCD screen reaches the REHEAT function. The top figure on the LCD screen indicates the preset REHEAT temperature of 165°C while the bottom figure indicates the preset time of '15 MINS'. The preset CONVECTION setting will also be displayed.



- The reheating temperature, time, convection and frozen settings can be adjusted before or during the reheating cycle.
 - The reheating temperature is displayed as the top figure on the LCD screen. Turn the TEMPERATURE dial to adjust the temperature from 50°C to a maximum of 230°C.
 - The reheating time is displayed as the bottom figure on the LCD screen. Turn the TIME dial to adjust the time up to 2 hours.
- Press the START/CANCEL button to activate the REHEAT function. The button backlight will illuminate red, the oven alert will sound and the LCD screen will illuminate orange.
- The timer will be displayed and begin to count down. The temperature and time can be adjusted during the reheating cycle by turning the corresponding TEMPERATURE and TIME dial. The cycle can be stopped at any time by pressing the START/CANCEL button.
- At the end of the REHEAT cycle, the oven alert will sound. The START/CANCEL button backlight will go out and the LCD screen will illuminate blue.

9. WARM FUNCTION

The WARM function maintains hot foods at the recommended temperature to prevent bacterial growth, 70°C or above.

1. Insert the wire rack into a rack position that best suits the type of food you are keeping warm.
2. Place food, positioned on the included roasting pan, pizza pan or other oven-proof dish, on the center of the wire rack so air will flow around all sides of the food.
3. Close the oven door.
4. Turn the FUNCTION dial until the indicator on the LCD screen reaches the WARM function. The top figure on the LCD screen indicates the preset temperature of 70°C, while the bottom figure indicates the preset time of '1 HRS'. The preset KEEP WARM symbol will also be displayed.

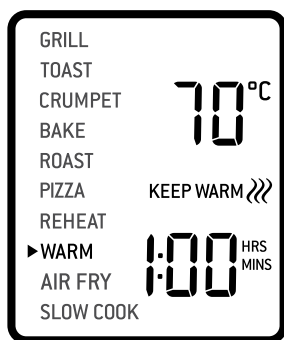

5. The temperature, time and convection settings can be adjusted before or during the warming cycle.
 - a) The warming temperature is displayed as the top figure on the LCD screen. Turn the TEMPERATURE dial to adjust the temperature from 50°C to a maximum of 230°C.
 - b) The time is displayed as the bottom figure on the LCD screen. Turn the TIME dial to adjust the time up to 2 hours.
6. Press the START/CANCEL button to activate the WARM function. The button backlight will illuminate red, the oven alert will sound and the LCD screen will illuminate orange.

7. The timer will be displayed and automatically begin to count down. The temperature and time can be adjusted during the warming cycle by turning the corresponding TEMPERATURE and TIME dial. The cycle can be stopped at any time by pressing the START/CANCEL button.
8. At the end of the WARM cycle, the oven alert will sound. The START/CANCEL button backlight will go out and the LCD screen will illuminate white.

AIR FRY FUNCTION

The AIR FRY function combines intense heat and maximized airflow to cook foods crispy and brown.

1. Insert the air frying basket into the top rack height position.
2. Close the oven door.
3. Turn the FUNCTION dial until the indicator on the LCD screen reaches the AIR FRY function. The top figure on the LCD screen indicates the preset AIR FRY setting of 220°C, while the bottom figure indicates the preset time of '15 MINS'. The preset SUPER CONVECTION setting will also be displayed.



4. The AIR FRY temperature, time, convection and frozen settings can be adjusted before or during the AIR FRY cycle.
 - a) The AIR FRY temperature is displayed as the top figure on the LCD screen. Turn the TEMPERATURE dial to adjust the AIR FRY temperature from 50°C to a max of 230°C.

- b) The AIR FRY time is displayed as the bottom figure on the LCD screen. Turn the TIME dial to adjust the time up to a maximum of 2 hours.
5. Press the START/CANCEL button to activate the AIR FRY function. The button backlight will illuminate red, the oven alert will sound and the LCD screen will illuminate orange. The LCD screen will indicate a blinking 'PREHEATING'.
6. Once the oven has finished preheating, an alert will sound and food can be inserted into the oven.
7. Arrange food evenly on the included air fry basket. For best results, place food in a single layer and leave space between pieces. Insert the air fry basket into rack position. Close the oven door.
8. After the PREHEATING alert has sounded, the timer will automatically begin to count down. The cycle can be stopped at any time by pressing the START/CANCEL button.
9. At the end of the AIR FRY cycle, the oven alert will sound. The START/CANCEL button backlight will go out and the LCD screen will illuminate blue.



IMPORTANT

When cooking fatty foods (e.g. chicken wings) we recommend using the grilling rack (placed in the roasting pan) instead of the air fry basket to prevent the oil dripping. Discard excess oil in between the batches.

SLOW COOK FUNCTION

The SLOW COOK function has cooking profiles designed for long cook times at low temperatures.

1. Insert the wire rack, with the spokes facing upward, into the bottom rack height position.
2. Close the oven door.
3. Turn the FUNCTION dial until the indicator on the LCD screen reaches the SLOW COOK function. The top figure on the LCD screen indicates the preset SLOW COOK temperature of 'HI', while the bottom figure indicates the preset time of '4HRS'. The preset CONVECTION setting will also be displayed.



4. The slow cook temperature, time and convection settings can be adjusted before or during the slow cook cycle.
 - a) The temperature is displayed as the top figure on the LCD screen. Turn the TEMPERATURE dial to adjust slow cooking to one of two preset temperatures: 'LO' or 'HI'.
 - b) The time is displayed as the bottom figure on the LCD screen. Turn the TIME dial to adjust the up to 10 hours.
5. Place food, inside covered oven-proof cookware, on the center of the wire rack so air will flow around all sides of the food. Close the oven door.
6. Press the START/CANCEL button to activate the SLOW COOK function. The button backlight will illuminate red, the oven alert will sound and the LCD screen will illuminate orange. The LCD screen will indicate a blinking 'PREHEATING'.

7. After the PREHEATING alert has sounded, the timer will automatically begin to count down. The cycle can be stopped at any time by pressing the START/CANCEL button.
8. At the end of the SLOW COOK cycle, the oven will automatically switch to the WARM function. The LCD screen will display 'KEEP WARM' and a keep warm time of '2:00 HR/MIN' will automatically count down. The keep warm cycle can be stopped at any time by pressing the START/CANCEL button.



NOTE

Do not pull the wire rack further than halfway out when inserting or removing cookware from the oven.

Do not allow heavy cookware to rest on the glass when the door is open.



TIPS

TIPS FOR SLOW COOKING

1. Ensure cookware is oven-proof and does not exceed 6 kgs when empty.
2. Fill cookware to a minimum of $\frac{1}{2}$ and maximum of $\frac{3}{4}$ full to avoid over or under-cooking. To prevent spillover, do not fill cookware more than $\frac{3}{4}$ full.
3. Always slow cook with the lid on to prevent food from drying out. Cover cookware with a layer of aluminum foil before covering with lid to keep even more moisture in.
4. Follow cooking temperatures and times prescribed in traditional slow cooker recipes. One hour on 'HI' is equivalent to approximately one-and-a-half to two hours on 'LO'.
5. Cold food will take longer to cook than food that has been pre-seared or heated so adjust cooking times as appropriate. Do not slow cook frozen foods.
6. Cut large pieces of meat in half to allow heat to penetrate more evenly.

REPLACING THE OVEN LIGHT



WARNING

Always unplug oven and let cool before replacing bulb. Only use a 25-Watt, 220-240V, G9 type oven bulb.

1. Remove the wire rack from the oven before replacing the light.
2. The light is positioned on the lefthand side of the oven cavity. Position your fingers on the outside of the light housing and gently pull the glass cover away from the oven wall to remove it. If you are unable to pull the cover off, slide a spoon into the left side of the light housing and gently lever the glass cover off. Always hold the glass cover with the other hand to prevent the cover from falling and breaking.

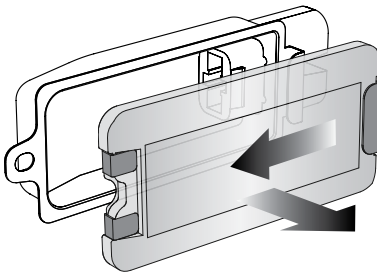

3. Remove the used bulb by pulling it directly out of its holder.

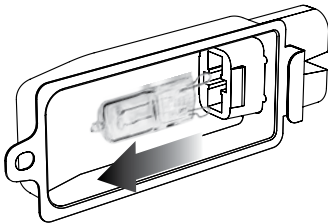

4. Use a soft cloth to insert the new bulb. Do not directly touch the surface of the bulb with your fingers as oil from your skin can damage the bulb.

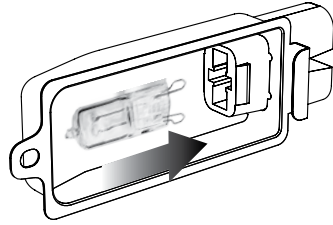

5. To reattach the glass cover, align the metal hook with the left side of the light housing. Slide the opposite end of the glass cover into the metal bracket on the right side of the housing, then push the metal hook into the left side of the housing until it snaps securely into position.

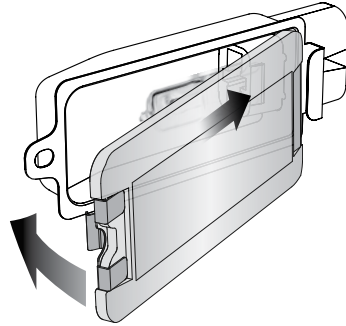

NOTE

The top of the oven is very hot during and after operation. As a result, storing items on top of the oven is not recommended.

The only exception is the optional Breville Bamboo Cutting Board and Serving Tray that fits in the ribbed section on top of the oven. Visit www.breville.com for more information.



Care & Cleaning

Before cleaning, ensure the oven is turned off by removing the power plug from the power outlet. Allow the oven and all accessories to cool completely before disassembling and cleaning.

Cleaning the outer body and door

1. Wipe the outer body with a soft, damp sponge. A non-abrasive liquid cleanser or mild spray solution may be used to avoid build-up of stains. Apply the cleanser to the sponge, not the oven surface, before cleaning.
2. To clean the glass door, use a glass cleaner or mild detergent and a soft, damp sponge or soft plastic scouring pad. Do not use an abrasive cleanser or metal scouring pad as these will scratch the oven surface.
3. Wipe the LCD screen with a soft damp cloth. Apply cleanser to the cloth and not the LCD surface. Cleaning with dry cloth or abrasive cleaners may scratch the surface.
4. Let all surfaces dry thoroughly prior to inserting the power plug into a power outlet and turning the oven on.



WARNING

Do not immerse the body, power cord or power plug in water or any other liquid as this may cause electrocution.

Cleaning the interior

The walls on the inside of the oven feature a non-stick coating for easy cleaning. To clean any splattering that may occur while cooking, wipe the walls with a soft, damp sponge. A non-abrasive liquid cleanser or mild spray solution may be used to avoid build-up of stains. Apply the cleanser to the sponge, not the oven surface, before cleaning. Avoid touching the quartz heating elements.



WARNING

Use extreme caution when cleaning the quartz heating elements. Allow the oven to cool completely, then gently rub a soft, damp

sponge or cloth along the length of the heating element. Do not use any type of cleanser or cleaning agent. Let all surfaces dry thoroughly prior to inserting the power plug into a power outlet and turning the oven on.

Cleaning the crumb tray

1. After each use, slide out the crumb tray and discard crumbs. Wipe the tray with a soft, damp sponge. A non-abrasive liquid cleanser may be used to avoid build-up of stains. Apply the cleanser to the sponge, not the tray, before cleaning. Dry thoroughly.
2. To remove baked-on grease, soak the tray in warm soapy water then wash with a soft sponge or soft plastic scouring pad. Rinse and dry thoroughly.
3. Always reinsert the crumb tray into the oven after cleaning and prior to inserting the power plug into a power outlet and turning the oven on.

Cleaning the wire rack, grilling rack, roasting pan and pizza pan

1. Wash all accessories in warm soapy water with a soft sponge or soft plastic scouring pad. Rinse and dry thoroughly. Do not use abrasive cleansers, metal scouring pads or metal utensils to clean any of the accessories as they may damage the surfaces.
2. To extend the life of your accessories, we do not recommend that these be placed in the dishwasher.

Storage

1. Ensure the oven is turned off by removing the power plug from the power outlet.
2. Allow the oven and all accessories to cool completely before disassembling and cleaning.
3. Ensure the oven and all accessories are clean and dry.
4. Ensure the crumb tray is inserted into the oven; the broiling rack is inserted into the roasting pan and resting on the wire rack in the middle rack height position.
5. Ensure the door is closed.
6. Store the appliance in an upright position standing level on its support legs. Do not store anything on top. The only exception is the optional Breville Bamboo Cutting Board and Serving Tray.



Troubleshooting

POSSIBLE PROBLEM	EASY SOLUTION
------------------	---------------

Oven will not switch "ON"	<ul style="list-style-type: none">• Check that the power plug is securely inserted into the outlet.• Insert the power plug into an independent outlet.• Insert the power plug into a different outlet.• Reset the circuit breaker if necessary.
The LCD display light has gone out	<ul style="list-style-type: none">• The oven goes into standby mode if not used for 10 minutes. When in standby mode, the LCD screen will cease to illuminate, however all function options will still be visible.• To re-activate the oven out of standby mode, press the START/CANCEL button on the control panel, or turn any dial. The LCD screen will re-illuminate.
The pizza does not cook evenly	<ul style="list-style-type: none">• Some large pizzas may brown unevenly in compact ovens. Open the oven door half way through the cooking time and turn the pizza 180 degrees for more even darkness.
The Magnetic Auto-Rack Eject comes out too far when I open the door	<ul style="list-style-type: none">• Always open the door slowly and in a controlled manner when the wire rack is inserted into the middle rack height position to prevent the wire rack from ejecting too quickly.
I cannot select the FROZEN FOODS button	<ul style="list-style-type: none">• The FROZEN button is only selectable for the following functions: TOAST, CRUMPET, BAKE, PIZZA, AIR FRY. When selecting the FROZEN button, this will automatically adjust the cooking time for an optimised food result.
Steam is coming out from the oven door	<ul style="list-style-type: none">• This is normal. The door is vented to release steam created from high moisture content foods such as frozen breads. Be mindful that the steam can be hot.
The heating elements appear to be pulsing	<ul style="list-style-type: none">• Element IQ™ accurately controls the heat inside the oven by pulsing the power and adjusting the power level in the heating elements in short bursts to give accurate temperature control. This is normal.
Water is dripping onto counter from under door	<ul style="list-style-type: none">• This is normal. The condensation created from high moisture content foods such as frozen breads will run down the inside of the door and can drip onto the counter.
The temperature reading on the LCD screen doesn't match the temperature measured inside the oven	<ul style="list-style-type: none">• To ensure the measurements are standardized, the oven temperatures have been calibrated in the TOAST position (center of the middle rack with no tray in place). Re-check the temperature in this position, ensuring not to open the oven door for 30 minutes as heat will escape each time the door is opened. Note that the 'preheat' alert sounds at 75% of the target temperature.

POSSIBLE PROBLEM	EASY SOLUTION
-------------------------	----------------------

The 'preheat' alert sounds at a lower temperature than what is displayed on the LCD screen

- The 'preheat' alert sounds at 75% of the target temperature. This provides the fastest, combined preheating and cooking time.
- This is because when the 'preheating' alert sounds, signaling the user to open the oven door and insert food, there is dramatic temperature loss inside the oven. If the alert sounded at 100% of the target temperature, opening the door would mean a lot of this waiting time is "wasted". We have calculated that by sounding the alert at 75% of the target temperature, followed by the oven door being opened to place food inside the oven, that we still recover to the target temperature up to 2 minutes faster. This is why the temperature on the LCD screen does not match the target temperature at the 'preheat' alert. Depending on the set temperature, it can take the oven approximately 8-10 minutes from start-up, including opening the oven door when the 'preheat' alert sounds, to reach the target temperature.

The LCD screen displays 'E01'

- The LCD screen will display 'E01' when there is a non-resettable issue with the appliance. Should this occur, immediately remove the power cord from the power outlet and call Breville Consumer Support.

The LCD screen displays 'E02'

- The LCD screen will display 'E02' when there is a non-resettable issue with the appliance. Should this occur, immediately remove the power cord from the power outlet and call Breville Consumer Support.

The LCD screen displays 'E03'

- The LCD screen will display 'E03' if the oven temperature is above the set maximum limit. Remove the plug from the power outlet, allow the oven to cool for 15 minutes, then plug back in.
- Call Breville Consumer Support if the 'E03' message continues.

The LCD screen displays 'E05'

- The LCD screen will display 'E05' when there is a non-resettable issue with the appliance. Should this occur, immediately remove the power cord from the power outlet and call Breville Consumer Support.

Temperature are changing when convection button is pressed

- This is normal. The temperature is calibrated to compensate for the convection fan increasing cooking rates.
-

Breville Customer Service Centre

Australian Customers

Phone: 1300 139 798

Web: www.breville.com

New Zealand Customers

Phone: 0800 273 845

Web: www.breville.com

Breville®

Breville, the Breville Logo, Smart Oven and Element IQ are trademarks of Breville Pty Ltd ("Breville") and Breville's products are distributed in Australia and New Zealand under license.

Copyright Breville Pty. Ltd. 2018.

Due to continued product improvement, the products illustrated/photographed in this brochure may vary slightly from the actual product.