

**Kelvinator** 

**Inverter Split System Room Air Conditioner**

**User Manual**

KSV26CRE, KSV26HRE, KSV35CRE, KSV35HRE,  
KSV53HRE, KSV62HRE, KSV70CRE, KSV70HRE,  
KSV80HRE

Refrigerant R32



## Congratulations

Congratulations and thank you for choosing our Inverter split system room air conditioner. We are sure you will find your new air conditioner a pleasure to use. Before you use the air conditioner, we recommend that you read through the entire user manual, which provides the description of the air conditioner and its functions.

To avoid the risks that are always present when you use an electrical appliance, it is important that the air conditioner is installed correctly and that you read the safety instructions carefully to avoid misuse and hazards.

We recommend that you keep this instruction booklet for future reference and pass it on to any future owners.

After unpacking the air conditioner please check it is not damaged. If in doubt, do not use the air conditioner but contact your local Electrolux Customer Care Centre.

### **environmental tip**

#### **Information on disposal for users**

- Most of the packing materials are recyclable. Please dispose of those materials through your local recycling depot or by placing them in appropriate collection containers.
- If you wish to discard this air conditioner, please contact your local authorities and ask for the correct method of disposal.

### **refrigerant warning**

This unit uses refrigerant R32 and must be disposed of by a licensed refrigeration mechanic with knowledge of appropriate gas reclamation methods.

### **caution**

- The air conditioner is not intended for use by young children or infirm persons without supervision.
- Young children should be supervised to ensure that they do not play with the air conditioner.
- Contact an authorised installer for installation of this unit.
- Contact an authorised service technician for repair or maintenance of this unit.
- If the power cord is to be replaced, replacement work shall be performed by authorised personnel only.
- Installation work must be performed in accordance with the national wiring Standards by authorised personnel only.

## Contents

### **Safety Instructions**

Warnings .....	3
Prior to operation.....	4

### **Product description**

Diagram.....	5
Indoor display unit .....	6
Remote control.....	7
First use .....	9

### **How to operate the air conditioner**

Automatic operation.....	10
Cooling/Heating/Fan only operation .....	10
Dehumidifying operation.....	10
Setting the clock .....	11
Timer operation .....	12
Eco operation .....	13
Emergency operation.....	15
Operating temperature.....	15

### **Maintenance**

Cleaning the filters.....	16
---------------------------	----

### **Operating tips**

Operation tips .....	18
Troubleshooting tips.....	19

### **Warranty**

Warranty instructions .....	23
-----------------------------	----

## Safety instructions

- Contact an authorised installer for installation of this unit.
- Contact an authorised service technician for repair or maintenance of this unit.
- The socket outlet required to supply power must be connected and commissioned by a licensed contractor.
- This appliance is not intended for use by persons (including children) with reduced physical, sensory or mental capabilities, or lack of experience and knowledge, unless they have been given supervision or instruction concerning use of the appliance by a person responsible for their safety.
- Young children should be supervised to ensure that they do not play with the air conditioner.
- If the power cord is to be replaced, replacement work shall be performed by authorised personnel only.
- Installation work must be performed in accordance with the national wiring standards and the electricity suppliers service rules by authorised personnel only.
- If the system is to be moved to another location or disposed of, only a suitably qualified person is permitted to undertake such work.
- Take care not to catch fingers on the fan blade when adjusting vertical louvres.
- This air conditioner uses R32 refrigerant.

### How to properly use and maintain your air conditioner

Just a little preventative care on your part can save you a great deal of time and money over the life of your air conditioner. You'll find many answers to common problems in the chart of troubleshooting tips. If you review the chart of Troubleshooting Tips first, you may not need to call for service.

Meanings of symbols used in this manual are shown below:



**warning**

This symbol indicates information concerning your personal safety



**caution**

This symbol indicates information on how to avoid damaging the appliance



**tips and information**

This symbol indicates tips and information about use of the appliance



**environmental tip**

This symbol indicates tips and information about economical and ecological use of the appliance



This symbol indicates always do this



This symbol indicates never to do this





**warning**

	Do not use means to accelerate the defrosting process or to clean, other than those recommended by the manufacturer.
	Do not store the appliance in a room with continuously operating ignition sources (for example open flames, an operating electric heater or an operating gas appliance with a continuously lit pilot flame).
	Do not pierce or burn.
	Be aware that the refrigerant may be odourless.
	Ensure the unit is properly connected to the power. Excess heat generation caused by incorrect connection may result in an electric shock or fire.
	Do not operate or stop the unit by switching on or off at the power source. This may cause an electric shock or fire due to excess heat generation.
	Do not damage or use an unspecified power cord. This may cause an electric shock or fire.
	Do not modify power cord length or share the outlet with other appliances. This may cause an electric shock or fire due to excess heat generation.
	Do not operate with wet hands or in damp environment. This may cause an electric shock.
	Do not direct airflow at room occupants only. This could damage your health.
	Always ensure that the unit is correctly earthed. No earthing may cause electric shock.
	Do not allow water to run into electric parts. It may cause failure of the unit or electric shock.
	Always install circuit breaker and a dedicated power circuit. Improper installation may cause fire and electric shock.
	Disconnect the power if strange sounds, smells, or smoke come from the unit. It may cause fire and electric shock.
	Do not drink water drained from air conditioner. It contains contaminants and could make you sick.
	Do not open the unit during operation. It may cause electric shock.
	Use correctly rated circuit breaker or fuse. There is risk of fire or electric shock.
	Do not use the power cord close to heating appliances. It may cause fire and electric shock.
	Do not use the power cord near flammable gas or combustibles, such as gasoline, benzene, thinner, etc. It may cause an explosion or fire.
	Ventilate room before operating air conditioner if there is a gas leakage from another appliance. It may cause explosion, fire and burns.
	Do not disassemble or modify unit. It may cause failure and electric shock.



## Safety instructions

### **caution**

	<b>When the air filter is to be removed, do not touch the metal parts of the unit.</b> It may cause an injury.
	<b>Do not clean the air conditioner with water.</b> Water may enter the unit and degrade the insulation. It may cause an electric shock.
	<b>Ventilate the room well when used together with a stove, etc.</b> An oxygen shortage may occur.
	<b>Do not put a pet or house plant where it will be exposed to direct air flow.</b> This could injure the pet or plant.
	<b>Do not use for special purposes.</b> Do not use this air conditioner to preserve precision devices, food, pets, plants, and art objects. It may cause deterioration of quality, etc.
	<b>Stop operation and close the window in storm or hurricane.</b> Operation with windows open may allow rain inside, soaking carpets and furniture.
	<b>Do not place obstacles around air-inlets or inside of air-outlet.</b> It may cause failure of appliance or accident.
	<b>Turn off at the main power switch if the unit will not be used for a long period of time.</b> It may cause failure of the unit or fire.
	<b>Do not use strong detergent such as wax or thinner. Use a soft cloth for cleaning.</b> Appearance may be deteriorated due to change of product colour or scratching of its surface.
	<b>Ensure that the installation bracket of the outdoor appliance is not damaged due to prolonged exposure.</b> If bracket is damaged, the unit may fall and damage may occur.
	<b>Always insert the filters securely. Clean filter once every two weeks.</b> Operation without filters may cause failure.
	<b>Do not place heavy object on the power cord and take care so that the cord is not compressed.</b> There is danger of fire or electric shock.
	<b>Use caution when unpacking and installing.</b> Sharp edges could cause injury.
	<b>If water enters the unit, turn the unit off and disconnect the power, contact a qualified service technician.</b>
	<b>Hold the plug by the head of the power plug when taking it out.</b> Failure to do so may cause electric shock and damage.

### **Prior to Operation**

- 1 Contact an installation specialist for installation.
- 2 Plug in the power plug properly.
- 3 Do not use a damaged or non-standard power cord.
- 4 Do not share the same outlet with other appliances.
- 5 Do not use an extension cord.
- 6 Do not start/stop operation by plugging /unplugging the power cord.

### **Usage**

- 1 Exposure to direct airflow to occupants, pets or plants for an extended period of time could be hazardous to your health.
- 2 Due to the possibility of oxygen deficiency, ventilate the room when used together with stoves or other heating devices.
- 3 Do not use this air conditioner for non-specified special purposes ( e.g. preserving precision devices, food, pets, plants, and art objects). Usage in such a manner could harm your property.

### **Cleaning and maintenance**

- 1 Do not touch the metal parts of the unit when removing the filter. Injuries can occur when handling sharp metal edges.
- 2 Do not use water to clean inside the air conditioner. Exposure to water can destroy the insulation, leading to possible electric shock.
- 3 When cleaning the unit, first make sure that the power and circuit breaker are turned off.

### **Service**

For repair and maintenance, contact your authorised service dealer.

## Product Description

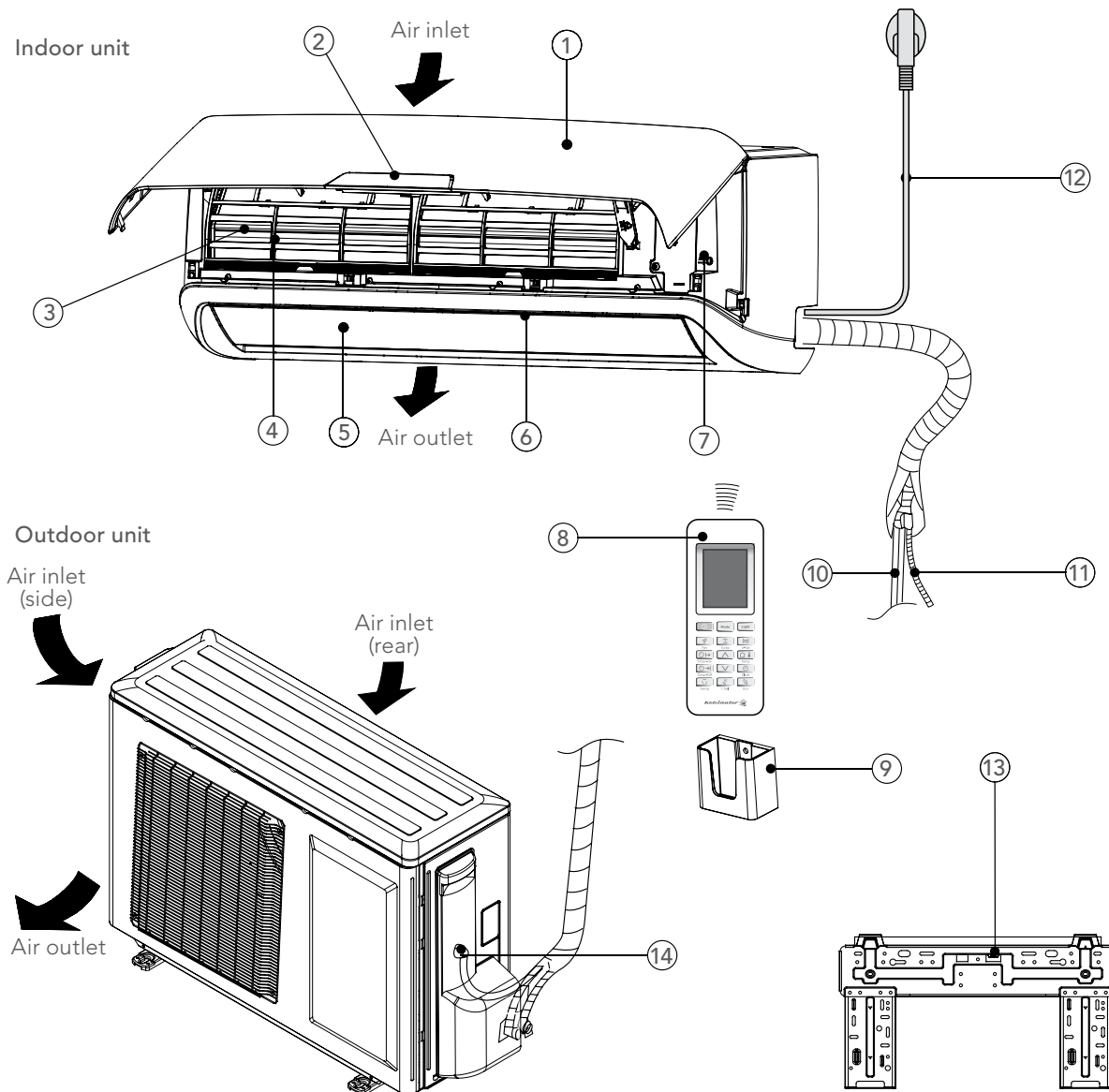

1. Front panel
2. Digital display
3. Air filter (behind the dust filter)
4. Pre-dust filter
5. Horizontal louvres
6. Vertical louvres
7. Manual control button
8. Remote control
9. Remote control holder

10. Refrigerant pipe (if applicable)
11. Drain hose (if applicable)
12. Power cable (if applicable)
13. Mounting plate
14. Connecting cable (if applicable)

*NOTE: All the pictures in this manual are for explanation purpose only. Your air conditioner may be slightly different. The actual shape shall prevail.*

## Indoor display unit





- 1 I feel indicator**  
Lights when the 'I feel' function is activated.
- 2 Turbo indicator**  
Lights when the 'TURBO' function is activated.
- 3 Eco (economy) indicator**  
Lights when the 'ECO' function is activated.
- 4 Temperature indicator**  
Displays the temperature settings when the air conditioner is in operation.
- 5 Timer indicator**  
Lights when the 'TIMER' function is set to ON or OFF.
- 6 Swing indicator**  
Lights when the 'SWING' function is activated.
- 7 Signal receiver**  
Receives signal from the remote control.

## Remote control

### Location of the remote control

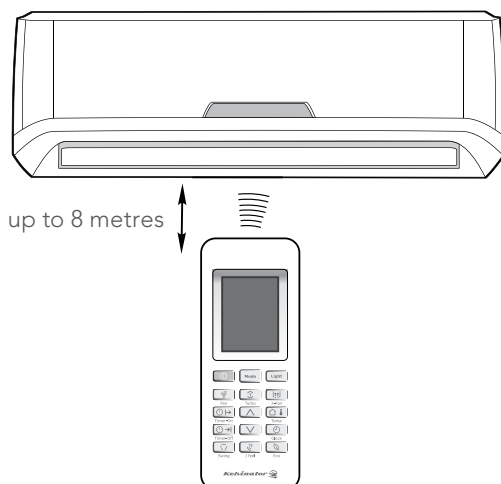
- Keep the remote control where its signal can reach the receiver of the indoor unit (a distance of up to 8m is allowed).
- When you select the timer operation, the remote control automatically transmits a signal to the indoor unit at the specified time.
- If you keep the remote control in a position that hinders proper signal transmission, a time lag of up to 15 minutes may occur.



- When the remote control sends out a signal, the symbol  will blink for about 1 second on the display of the remote control.

### **caution**

- The air conditioner will not operate if curtains, doors or other materials block the signals from the remote control to the indoor unit.
- Prevent any liquid from entering the remote control. Do not expose the remote control to direct sunlight or heat.
- If the infrared signal receiver on the indoor unit is exposed to direct sunlight, the air conditioner may not function properly. Use curtains to prevent the sunlight from falling on the receiver.
- **If other electrical appliances react to the remote control, either move these appliances or consult your local dealer.**

### Replacing batteries

The remote control uses two AAA dry cell batteries.

- 1 Slide the cover of the battery compartment off according to the arrow direction, then replace the old batteries with new ones.
- 2 Insert the new batteries making sure that the (+) and (-) of the batteries are installed correctly.
- 3 Reattach the cover by sliding it back into position. The remote control clock will need to be reset after replacing the batteries.

*NOTE: Do not dispose batteries as unsorted municipal waste. Collection of such waste separately for special treatment is necessary.*

### **tips and information**

- When changing batteries use only new and matching batteries, otherwise, it may cause problems with the remote control.
- If the remote control is not used for a long time, remove the batteries as old batteries may leak or corrode and damage the remote control.
- The battery life during normal use is about six months.
- If the remote control does not operate normally, please remove and refit the batteries. If abnormal operation continues, replace with new batteries.

# Remote control

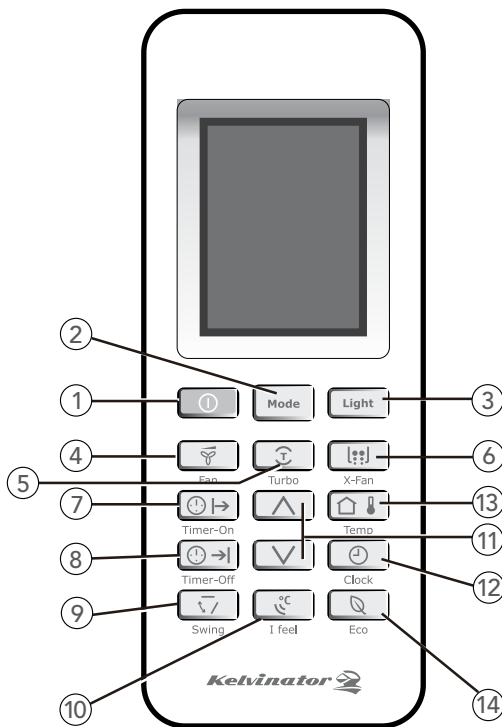

- 1 **ON/OFF Button**  
Push this button to start or stop operation.
- 2 **MODE Select Button**  
Each time you push the button, a mode is selected in a sequence that goes from AUTO, DEHUMIDIFY, FAN, COOL and HEAT, as the following figure indicates:
- 3 **LIGHT Button**  
Press this button to switch the indicating lights of the indoor unit ON or OFF. The normal condition at start up is ON.
- 4 **FAN Button**  
By pressing this button, Auto, Low, Medium and High speed can be progressively selected. When the unit is turned on, Auto fan speed is the default.  
In DEHUMIDIFY mode, the fan speed is fixed at Low speed.
- 5 **TURBO Button**  
Press this button in COOL or HEAT mode to put the fan into the high speed Turbo mode and the air conditioner will work at maximum power.  
Press again to cancel this function.

*NOTE: Cooling Only models have no HEAT mode.*

- 6 **X-FAN Function**  
Press the X-FAN button to activate the X-FAN function.  
After the unit is turned off, the indoor fan will continue to operate for 10 minutes to remove all moisture from the indoor unit and prevent bacteria and mildew from growing.
- 7 **TIMER ON Button**  
Press this button to set the start time.
- 8 **TIMER OFF Button**  
Press this button to set the start time.
- 9 **SWING Button**  
Press this button to change the swing angle of the louvre. The angle of the horizontal louvre will adjust by 6 degrees with each press of the button. If you keep pressing the button for 2 or more seconds, the louvre will swing up and down automatically.
- 10 **I FEEL Button**  
Push this button to initiate the I FEEL feature, the remote displays the temperature at its location. The remote control will send this signal to the air conditioner in 3 minute intervals until you press the I FEEL button again. The air conditioner will automatically cancel the I FEEL feature if it does not receive the signal during any 7 minute interval.  
*NOTE: The I FEEL feature is not available under DRY and FAN mode. Shifting the operating mode or turning off the unit will cancel the I FEEL feature automatically. The remote control needs to be within 8m reach of the indoor unit for the I FEEL mode to work appropriately.*
- 11 **CONTROL Buttons**  
   
Press the ^ button to increase the temperature setting.  
Press the v button to decrease the temperature setting.  
In TIMER ON/OFF or CLOCK functions, use these buttons to adjust the timer or set the clock.
- 12 **CLOCK Button**  
Press this button and the Clock symbol ⌚ will blink. You can press Control buttons ^ and v to set the time you want.
- 13 **TEMP (Temperature) Button**  
Press this button to change the remote control display of the set temperature to the room temperature.
- 14 **ECO (Economy) Button**  
Press this button to go into the Energy-Saving operating mode. Press it again to cancel. This function is ideal for maintaining a comfortable sleeping temperature.

## Remote control display indicator

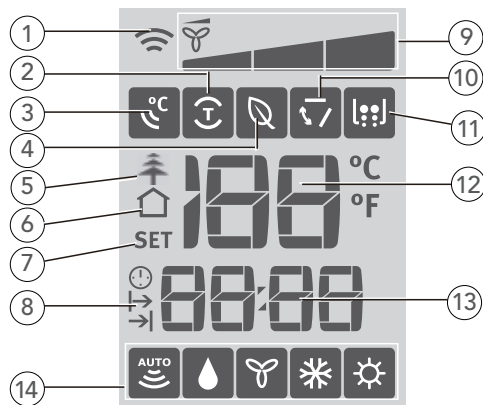

### 1 TRANSMISSION Indicator

Displays when the remote control transmits signals to the indoor unit.

### 2 TURBO Display

Displays when TURBO function is active.

### 3 I FEEL Display

Displays when the I FEEL function is active.

### 4 ECO Display

Displays when ECO function is active.

### 5 ACTIVE PLASMA Display (Active Plasma models only)

Displays when ACTIVE PLASMA function is selected. This function is not available for this range of air conditioners.

### 6 Room Temperature Display

Displays when the temperature shown on the LCD screen is room temperature. It can be switched on/off by pressing the TEMP button.

### 7 Programmed TEMPERATURE Display

Lights up when the remote control displays the set temperature. It can be switched on/off by pressing the TEMP button.

### 8 TIMER ON/OFF Display

Displays when the Timer On/Off function is activated.

### 9 FAN SPEED Display

Displays the selected fan speed in the following sequence:



and AUTO. In Auto speed, only the  symbol is displayed.

### 10 SWING Display

Displays when the SWING function is selected.

### 11 X-FAN Display

Displays when the X-Fan function is activated by pressing Turbo and Healthy buttons at the same time (for models with active plasma function) or by pressing X-Fan button (for models without active plasma function).



### 12 TEMPERATURE Display

Displays the room or set temperature in °C or °F. No display in Fan mode.

### 13 TIME Display

Displays the Clock time (must be set) and/or the on/off time of the timer.

### 14 MODE Display

Displays the current operation mode, including Auto () , Dehumidify () , Fan () , Cool () and Heat () .

*NOTE: The Cool model does not offer a Heating option.*



## First use

- 1 Ensure the unit is plugged in and power is available.
- 2 Be sure the batteries are inserted correctly in the remote control (the lights on the remote control will be on).
- 3 Set the time with the CONTROL buttons and confirm by pressing the CLOCK button.
- 4 Point the remote control at the indoor unit and press ON/OFF button to turn the unit on.

The default operating mode is AUTO. Once you select the operating mode with the remote control, the operating conditions will be saved in the indoor unit's memory. The next time the air conditioner will start operating under the same conditions when you simply push the ON/OFF button of the remote control.

### **i** tips and information

In case of a power cut, the unit being switched off at the powerpoint, or when changing the remote control batteries, the microprocessor will return to AUTO mode.

## Using the remote control

### Automatic operation

When you set the air conditioner to AUTO mode, it will automatically select cooling, heating (only for reverse cycle models), or fan only operation depending on which temperature you have selected and the ambient room temperature. Once you have selected the operating mode, the operating conditions are saved into the unit's memory. Thereafter, the air conditioner will start operating under the same conditions when you simply push the ON/OFF button on the remote control.

### Start

Ensure the unit is plugged in and power is available. The OPERATION indicator on the display panel of the indoor unit starts flashing.

- 1 ON/OFF Button  
Press this button to turn the air conditioner on. The temperature indicator on the indoor unit display lights up.
- 2 MODE Button  
Press to select AUTO.
- 3 CONTROL Buttons  
Set the desired temperature (normally, set between 21°C to 28°C). The air conditioner will begin functioning after approximately 3 minutes.

### Stop

- 1 ON/OFF Button  
Press this button again to turn the air conditioner off. The horizontal louvre returns to the closed position upon shut down.

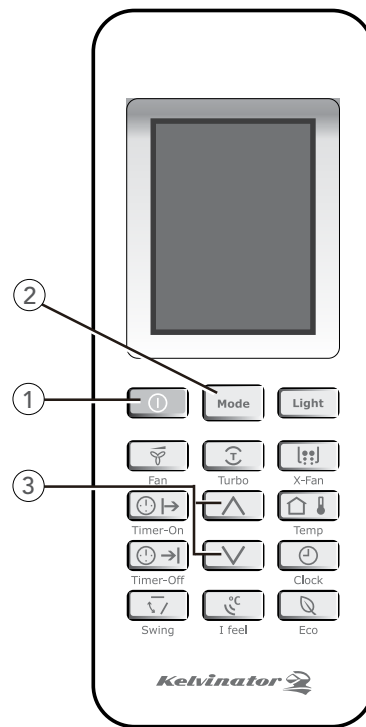

If the AUTO mode is not achieving the temperature you require, the desired conditions can be selected manually.

### **i** tips and information

When the AUTO operating mode is selected, the fan speed will be automatically controlled and cannot be set.

## Dehumidifying operation

The DEHUMIDIFY mode works based on the difference between the set temperature and the actual room temperature. The temperature is regulated while dehumidifying through repeatedly turning on/off of the COOLING operation on or off, or by turning the FAN only operation on or off.

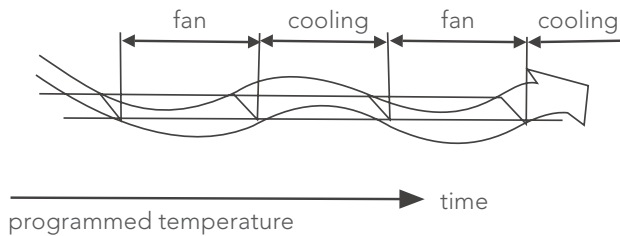

### Start

Ensure the unit is plugged in and power is available.

The OPERATION indicator on the display panel of the indoor unit starts flashing.

- 1 ON/OFF Button  
Press this button to turn the air conditioner on. The temperature indicator on the indoor unit display lights up.
- 2 MODE Button  
Press to select DEHUMIDIFY.
- 3 CONTROL Buttons  
Set the desired temperature (normally, set between 21°C to 28°C).

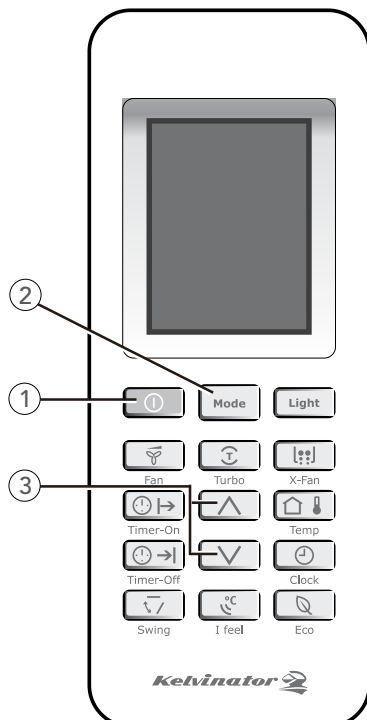

### Stop

- 1 ON/OFF Button  
Press this button again to turn the air conditioner off. The horizontal louvre returns to the closed position upon shut down.

### **i** tips and information

In DEHUMIDIFY mode the fan speed is fixed at Low, and Turbo function can be used.

## Fan operation

When you select the FAN operating mode the air conditioner will recirculate the indoor air.

- 1 ON/OFF Button  
Press this button to turn the air conditioner on. The temperature indicator on the indoor unit display lights up.
- 2 MODE Button  
Press to select FAN.
- 3 FAN Button  
Press to select the desired fan speed at: Auto, Low, Medium and High. The default fan speed is Auto.

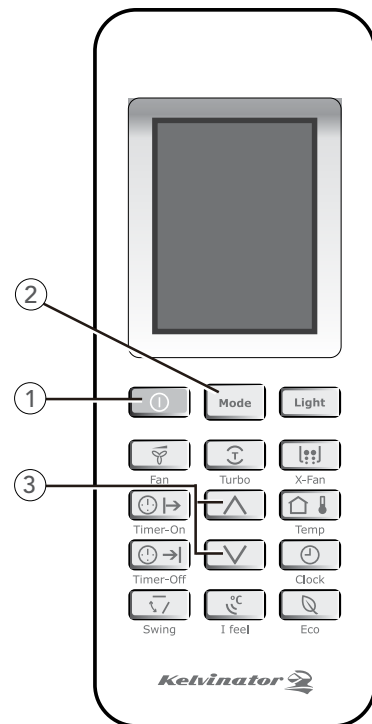

### Stop

- 1 ON/OFF Button  
Press this button again to turn the air conditioner off. The horizontal louvre returns to the closed position upon shut down.

### **i** tips and information

The temperature cannot be set through the remote control in FAN operating mode.

No fan speed indication displays on the remote control if Auto fan speed is selected.

## Cooling and heating operation

### Start

Ensure the unit is plugged in and power is available.

The OPERATION indicator on the display panel of the indoor unit starts flashing.

- 1 ON/OFF Button  
Press this button to turn the air conditioner on. The temperature indicator on the indoor display unit lights up.
- 2 MODE Button  
Press to select to COOL or HEAT (where applicable).
- 3 CONTROL Buttons  
Set the desired temperature (normally, set between 21°C to 28°C).
- 4 FAN Button  
Press to select the desired fan speed at: AUTO, LOW, MEDIUM and HIGH. The default fan speed is AUTO.

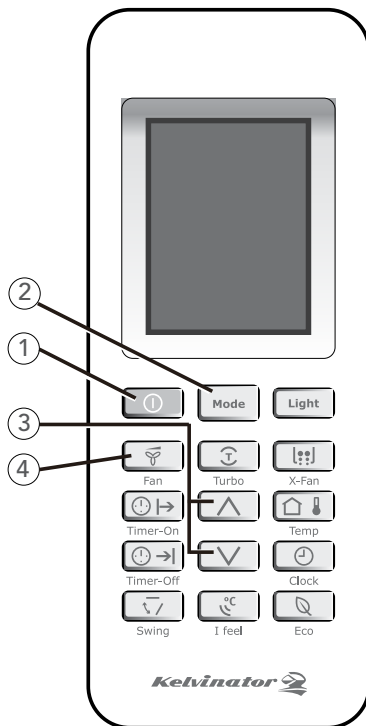

### Stop

- 1 ON/OFF Button  
Press this button again to turn the air conditioner off. The horizontal louvre returns to the closed position upon shut down.

## Setting the clock

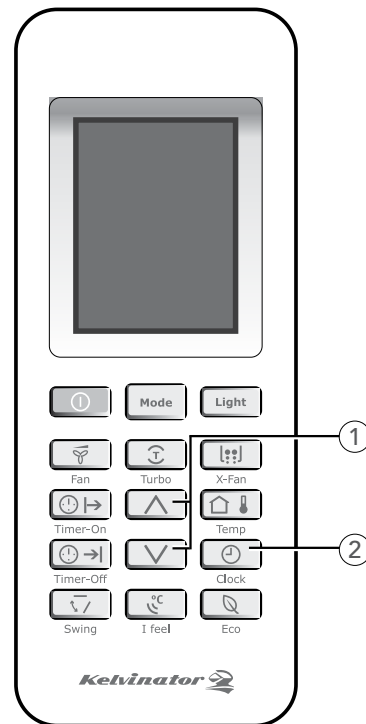

Before you start operating the air conditioner, set the clock on the remote control using the following instructions. The clock panel on the remote control will display the time regardless of whether the air conditioner is in operation or not.

After batteries are inserted in the remote control, **12:00** will display and begin to flash.

#### 1 CONTROL buttons

Set the desired time by pressing the CONTROL buttons:  
 ▲ Forward ▼ Backward

Each time you press the buttons the time will move forward or backward by 1 minute. Holding the button down will scroll more rapidly through the time display.

#### 2 CLOCK Button

When the desired time is achieved, press the CLOCK button again or after 5 seconds with no operation, the clock time stops flashing and the clock is set.

#### 3 Re-set the Clock

Press the CLOCK button and the clock display will start to flash.



Follow step 1 and 2 to set the new time.

### **i** tips and information

- The clock timer uses a 24 hour clock mode.
- The default time for remote control is 12:00PM and it will revert to this when the batteries are changed.

## Timer settings

### Timer-On Operation

- 1 Press the TIMER-ON button.  
 will flash on the display of the remote control the very first time the TIMER-ON operation is used. With all subsequent uses, the last set time will flash.
- 2 Set the desired time by pressing the CONTROL buttons:  
∧ Forward ∨ Backward  
Each time you press the buttons, the time will move forward or backward by 1 minute. Holding the button down will scroll more rapidly through the time display.
- 3 Point the remote control to the indoor unit, confirm the set time by pressing the TIMER-OFF button.  
 symbol will stay on the remote control's display.  
Check that the Timer indicator on the display panel of indoor unit is illuminated.

### Cancelling the Settings

Point the remote control at the indoor unit and press the TIMER-OFF button. Make sure the symbol  on the remote control is turned off.

### tips and information

- The timer function set by the remote control depends on the clock time. Check that the clock on the remote control is set correctly in order to prevent error.
- The effective operation time set by the remote control is limited to 24 hours.

### Examples of Timer Settings

#### Timer-On Operation (Timer Start Operation)

This function is recommended when you want the unit to be turned on automatically before returning home. The air conditioner will automatically start operating at the set time.

*Example: It is 8:00 AM and you want the air conditioner to start working at 6:00 PM.*

- 1 Press the TIMER-ON button.
- 2 Set the desired time by pressing repeatedly or holding down the CONTROL buttons until 18:00 shows in the display of the remote control.



- 3 Confirm the set time by pointing the remote control at the indoor unit and pressing the TIMER-ON button again.  
 symbol will stay on the remote control's display.  
The Timer indicator on the display panel of indoor unit will be illuminated.

### Timer-Off Operation (Timer Stop Operation)

This function is recommended when you want the unit to be turned off automatically (e.g. bedtime). The air conditioner will automatically stop operating at the set time.

*Example: It is 6:00 PM and you want the air conditioner to turn off at 11:55 PM.*

- 1 Press the TIMER-OFF button.  
 will flash on the display of the remote control the very first time the TIMER-ON operation is used. With all subsequent uses, the last set time will flash.
- 2 Set the desired time by pressing repeatedly or holding down the CONTROL buttons until 23:55 shows in the display of the remote control.



- 3 Confirm the set time by pointing the remote control at the indoor unit and pressing the TIMER-ON button again.  
 symbol will stay on the remote control's display.  
The Timer indicator on the display panel of indoor unit will be illuminated.

### Combined Timer

Timer-On → Timer-Off

(Off-Start-Stop operation)

This function is recommended when you want to turn the air conditioner on before waking up and turn it off after leaving the house.

*Example: It is 10:00 PM and you want to start the air conditioner at 6:30 AM and stop it at 9:30 AM.*

- 1 Press the TIMER-ON button.
- 2 Set the desired time by pressing repeatedly or holding down the CONTROL buttons until 06:30 shows in the display of the remote control.



- 3 Confirm the set time by pointing the remote control at the indoor unit and pressing the TIMER-ON button again.
- 4 Press the TIMER-OFF button.
- 5 Set the desired time by pressing repeatedly or holding down the CONTROL buttons until 09:30 shows in the display of the remote control.



## Economy (Eco) operation

- Confirm the set time by pointing the remote control at the indoor unit and pressing the TIMER-ON button again.

🕒 symbol will stay on the remote control display and  
 ➔ the function is activated.

Timer-Off ➔ Timer-On  
 (On-Stop-Start operation)

This function is recommended when you want to turn the air conditioner off after going to bed and start it again before waking up in the morning or returning home.

*Example: It is 8:00 AM and you want to stop the air conditioner at 9:30AM and restart at 6:00PM.*

- Press the TIMER-OFF button.
- Set the desired time by pressing repeatedly or holding down the Control buttons until 09:30 shows in the display of the remote control.



- Confirm the set time by pointing the remote control at the indoor unit and pressing the TIMER-OFF button again.
- Press the TIMER-ON button.
- Set the desired time by pressing repeatedly or holding down the Control buttons until 18:00 shows in the display of the remote control.



- Confirm the set time by pointing the remote control at the indoor unit and pressing the TIMER-ON button again.

🕒 symbol will stay on the remote control's display and  
 ➔ the function is activated.

Press ECO button in COOL or HEAT (if applicable) mode, the air conditioner will automatically increase (in COOL mode) or decrease (in HEAT mode) 1°C per hour for 2 hours. The set temperature will be steady for the next 5 hours then the unit will stop.

This function saves energy and is recommended for maintaining a comfortable sleeping temperature.

### Cooling

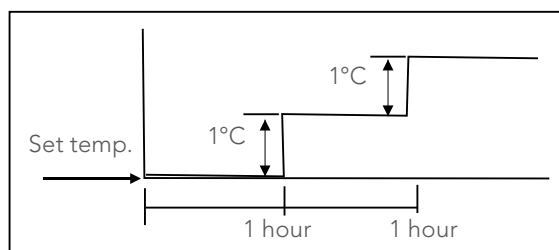

### Heating

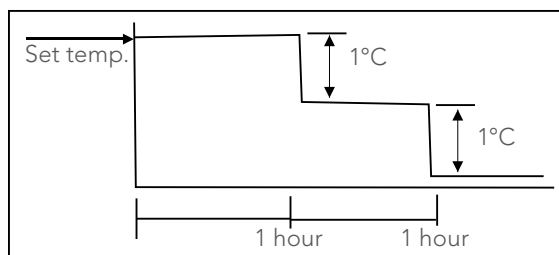

## I FEEL function

When the I FEEL function is activated, the remote control works as a remote thermostat, providing accurate temperature control and maximum comfort.

Point the remote control to the indoor unit and press the I FEEL button. A beep from the indoor unit confirms that this function is activated.

The I FEEL symbol will stay on the display of the remote control until I FEEL button is pressed again.

The air conditioner will operate to reach the set temperature at the location of the remote control.

The remote control sends the temperature information at its location to the indoor unit every ten (10) minutes.

The air conditioner will quit I FEEL operation if no temperature information is received from the remote control for eleven (11) successive minutes.



# How to use the indoor unit

## Additional options

- 1 Smart restart function  
The air conditioner automatically resumes the previous settings after a power failure.
- 2 Removable panel  
The front panel of indoor unit can be easily removed for cleaning and maintenance.
- 3 Self diagnosis and auto protection  
This air conditioner can detect malfunctions, showing the diagnosis on the display of the indoor unit with an error code. The air conditioner will change operation automatically for self-protection.

## Airflow direction control

- Adjusting the air flow correctly can prevent discomfort or uneven room temperatures.
- Adjust the horizontal louvres with the remote control.
- Adjust the vertical louvres manually.

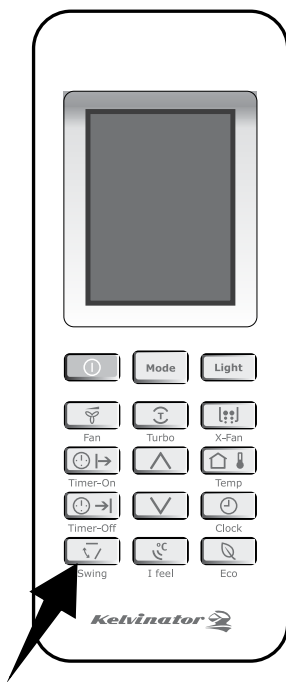

## To set the vertical (up/down) airflow direction automatically

- Perform this function while the unit is in operation.
- Press the SWING button on the remote control, the horizontal louvre will swing up and down automatically.
- When the louvre moves to the desired position, press the SWING button again and the louvre will stay where it is.
- Press the SWING button again and the louvre will start moving up and down automatically.

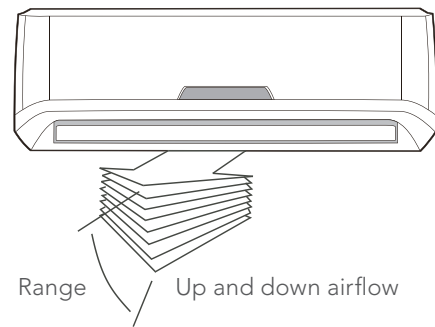

## To adjust the horizontal (left/right) airflow direction manually

- Always perform these adjustments while the unit is turned off as fingers coming into contact with the fan may be injured.
- Adjust the vertical louvres manually by means of the Left/Right lever of the vertical louvre arm.

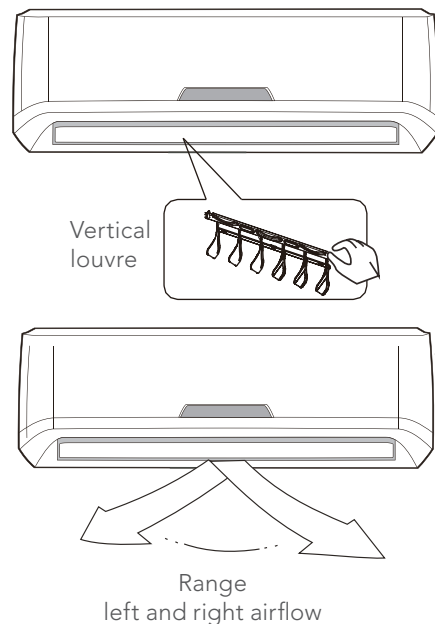

## **caution**

- The SWING button will be disabled when the air conditioner is not in operation (even if the Timer-On is set).
- Do not operate the air conditioner for long periods with the airflow direction set downward in COOL or DEHUMIDIFY mode. Otherwise, condensation may form on the surface of the horizontal louvre and drop onto the floor or furnishings.
- Do not move the horizontal louvre manually. Always use the Swing button. Moving the louvre manually may cause a malfunction during operation. If the louvre malfunctions, stop the air conditioner and restart it.
- The opening of the horizontal louvre should not be set too small, as cooling or heating performance may be affected by restricted airflow.
- Do not operate the air conditioner with horizontal louvre in closed position.
- When the air conditioner is connected to power (initial operation), the horizontal louvre may generate a sound for 10 seconds, this is a normal part of the operation.

## Emergency operation

When the remote control is lost or fails to operate, please use the manual switch on the indoor unit. The air conditioner will operate in AUTO mode and the temperature setting or fan speed cannot be changed.

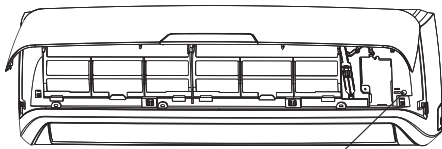
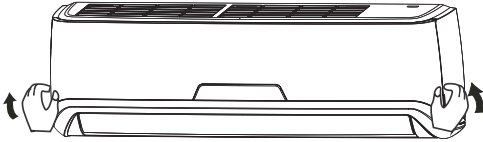

manual control button

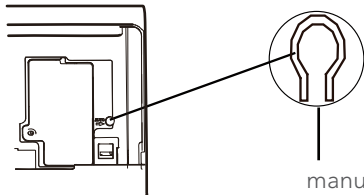

manual control button

- Press the Manual Control button to enter AUTO mode. The air conditioner will select the mode COOL, HEAT (heat pump model only) and FAN automatically according to the room temperature for reaching the best comfort.
- Press the Manual Control button again to turn the air conditioner off.

The operation mode is seen in the following table.

Mode	Model	Temperature setting	Airflow
AUTO	COOLING	25°C (COOL, FAN)	AUTO
AUTO	HEAT PUMP	25°C (COOL, FAN)	AUTO
AUTO	HEAT PUMP	20°C (HEAT)	AUTO

## Operating Temperature

Operating temperature ranges		
	Indoor side DB/WB°C	Outdoor side DB/WB°C
Maximum Cooling	32/23	43/26
Minimum Cooling	21/15	21/-
Maximum Heating	27/-	24/18
Minimum Heating	20/-	-7/-8

The operating temperature range (outdoor temperature) for cooling only model is 21°C~43°C, for reverse cycle (heat pump) models is -7°C~43°C.

If the air conditioner is used outside of the above conditions, certain control features may come into operation and cause the unit to function abnormally.

## Optimal Operation

To achieve optimal performance, please note:

- Adjust the airflow direction so that it is not aimed directly at people or pets.
- Adjust the temperature to achieve the highest comfort level. Do not adjust the unit to excessive temperature levels.
- Close doors and windows when using COOL or HEAT mode, otherwise, product performance will be reduced.
- Use the Timer-On and Timer-Off buttons on the remote control to select the desired time for start-up and shut-down.
- Do not place any object close to the air inlets or outlets, as it reduces the efficiency of the unit and may cause damage to the air conditioner.
- Clean the air filters frequently, otherwise cooling or heating performance may be reduced.

## Maintenance

The following maintenance operations must be performed regularly.

Item	Maintenance operations	Recommended frequency
Air filters	Clean	Every month or more often if necessary
Air freshening filter	Change/replace a new one	Every 4 months
Unit casing	Clean	Every month or more often if necessary
Water tray and evacuation piping	Clean and check for obstructions	Each season before start up*
Indoor/outdoor coils	Clean	Each season before start up*

\* This operation must be performed by qualified personnel only.



**warning**

Stop the air conditioner and disconnect the power supply before cleaning.

### Indoor unit and remote control cleaning

- Use a dry cloth to wipe the indoor unit and remote control.
- A cloth dampened with cold water may be used on the indoor unit if it is extremely dirty.
- The front panel of the indoor unit can be removed, cleaned with water then wiped with a dry cloth.
- Do not use scourers or steel wool to clean the unit as they may damage the unit.
- Do not use a chemically treated cloth or duster to clean the unit.
- Do not use benzene, thinners, polishing powder or similar solvents for cleaning. These may cause the plastic surface to crack or deform.
- Never use water over 40°C to clean the front panel, it may cause deformation or discolouration.

*NOTE: Supply power must be disconnected before cleaning the indoor unit.*

## Cleaning the filters

A clogged air filter reduces the cooling efficiency of this unit. Please clean the filter every month or more often if necessary.

- 1 Lift the front panel of the indoor unit until it stops with full support of the bracket.

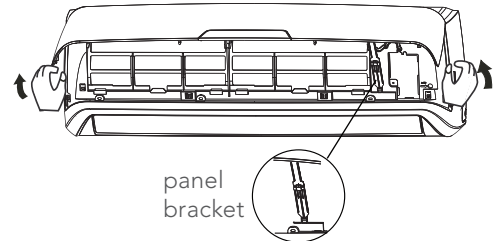

panel bracket

- 2 Hold the dust filter handle and lift it up slightly to take it out of the filter holder.

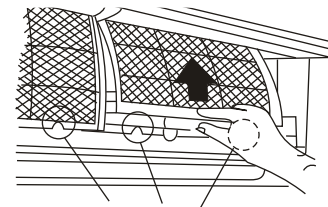

dust filter handle

- 3 Pull the dust filter downwards out of the indoor unit.

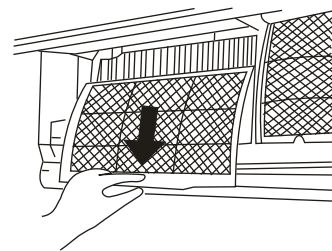

Clean the dust filter with a vacuum cleaner or water, then dry out of direct sunlight.

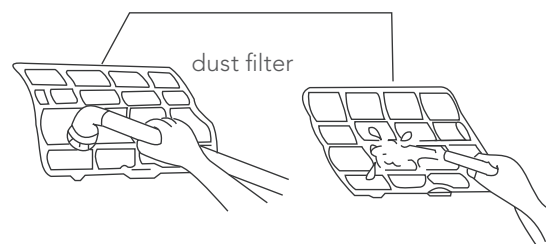

dust filter

- 4 The healthy air freshening filters (if applicable) like Active carbon filter / BIO filter / Vitamin C filter / Silver ion filter are fixed on the dust filter.

Remove the healthy air filters from the support frame of the dust filter.

Clean the healthy air filters at least every three (3) months and replace every 6 months.

Clean with vacuum cleaner if possible.

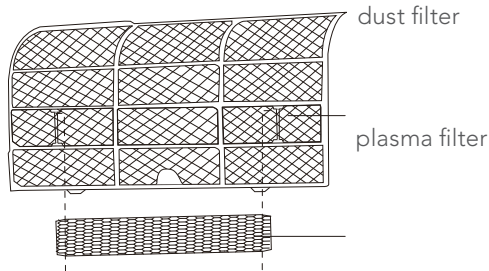

- 5 Install the healthy air filters back in position.

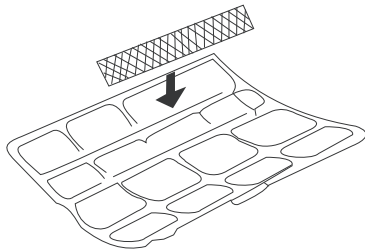

- 6 Install the upper portion of the dust filters back into the unit, taking care that the left and right edges line up correctly and place dust filters into position.

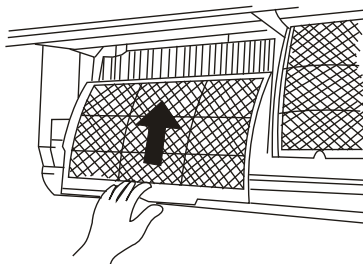

### General maintenance

If the air conditioner is not going to be used for a long period of time:

- Operate in FAN only mode for 3~4 hours to allow the unit to completely dry out.
- Switch off the unit and pull out the power plug.
- Remove the batteries from the remote control.
- The outdoor unit requires periodic maintenance and cleaning. Do not attempt to do this yourself. Contact your dealer or service technician.

### Checks before operation

- Check that the wiring is not broken or disconnected
- Check that the dust filter is installed.
- Check if the air outlet or inlet is blocked if the air conditioner has not been used for a long time.

### warning

Do not touch the metal parts of the unit when removing the filter. Injuries can occur when handling sharp metal edges.

Do not use water to clean inside the air conditioner. Exposure to water can destroy the insulation, leading to possible electric shock.

When cleaning the unit, first make sure that the power and circuit breaker are turned off.

# Operating tips

The following events may occur during normal operation.

## 1 Protection of the air conditioner

### Compressor protection

- The compressor will not restart for 3 minutes after it stops.

### Anti-freezing

- If the unit is operating in COOL mode in a low ambient temperature, frost may be formed on the heat exchanger. When the indoor heat exchanger temperature decreases below 0°C, the compressor will stop operation to protect the unit.

### Defrosting

- Frost may form on the outdoor unit in heating mode when the outdoor temperature is low but humidity is high, resulting in low heating efficiency.

When this occurs, the air conditioner will stop heating and start defrosting automatically. The defrosting time may vary from 3 to 12 minutes.

During defrosting, the fan motors of the indoor unit and outdoor unit will stop. The indoor indicator flashes "H1" and the outdoor unit may emit a vapour. This is not a malfunction. After defrosting is finished, the heating operation will resume automatically.

### Anti-cold air

- In HEAT mode, the indoor fan will not operate for up to 5 minutes if the indoor heat exchanger does not reach a minimum temperature for the following reasons:

- 1 Heating operation has just started.
- 2 Auto defrosting is just finished.
- 3 Heating at a low temperature.

This is in order to prevent cold air being blown into the room.

### Gentle breeze

- The indoor unit may blow gentle breeze and the louvre rotates to a certain position in the following situation:
  - 1 In HEAT mode, the unit is turned on, the compressor does not reach the starting condition.
  - 2 In HEAT mode, the temperature reaches the set value and the compressor stops running for about 1 minute.

### A white mist is coming out from the indoor unit

- A white mist may generate due to a large temperature differences between air inlet and air outlet in COOL mode in an indoor environment that has a high relative humidity.
- A white mist may generate due to moisture generated from defrosting process when the air conditioner restarts in HEAT mode operation after defrosting.

### Noises coming from the air conditioner

- You may hear a low hissing sound when the compressor is running or has just stopped running. This is the sound of the refrigerant flowing or coming to a stop.
- You also may hear a low "squeak" sound when the compressor is running or just stopped running. This is caused by heat expansion and cold contraction of the plastic parts in the unit when the temperature is changing.
- A noise may be heard due to louvre restoring to its original position when power is first turned on.

### Dust is blown out from the indoor unit

- This is a normal condition when the air conditioner has not been used for a long time or during first use of the unit.

### A peculiar smell comes out from the indoor unit

- This is caused by the indoor unit giving off smells permeated from building material, furniture or smoke.

### The air conditioner turns to FAN only mode from COOL or HEAT mode

- When the indoor temperature reaches the setting value, the compressor will stop automatically, and the air conditioner turns to FAN mode.

The compressor will start again when the indoor temperature rises in COOL mode or falls in HEAT mode to the set point.

### Condensation

- Water droplets are likely to form at the air outlet if cooling or drying for a long time when the relative humidity is more than 80% (with doors and windows open).

Set the vertical louvre to its maximum angle (to the floor) and High fan speed. Close the doors and windows.

### Other interferences

Lightning or a car wireless telephone operating nearby may cause the unit to malfunction. Disconnect the unit with power and then re-connect the unit with power again. Push ON/OFF button on the remote control to restart operation.

### X-Fan function

The indoor unit may keep running after you switch off the unit by pressing ON/OFF button. Please check whether the X-Fan function is switched off.



# Troubleshooting

The air conditioner is not user serviceable. Incorrect repair may cause electric shock or fire.

Please contact an authorised service centre for professional repair.



## warning

If one of the following situations occur, immediately stop the air conditioner, disconnect the power, and contact the authorised service centre.

- If an error code appears on the display window of the indoor unit.
- Power indicator or other indicators flash rapidly and this flashing cannot be stopped by disconnecting the power and then connecting it again.

- Fuse blows frequently or circuit breaker often trips.
- Water or other liquid is splashed into the unit.
- Water is leaking from the unit.
- There is a harsh sound during operation.
- Strong odours are emitted during operation.
- Power cord and power plug are overheating.
- Other abnormal situations.

The pressure in the refrigeration system is low and could result in the unit breaking down.

Ask a certified installer to adjust the pressure.

If the trouble has not been corrected, please contact a local dealer or the nearest customer service centre. Be sure to inform them of the detailed malfunctions and unit model.

Problem	Possible cause	Solution
The unit does not start	Power cut	Wait for power to be restored
	The unit may have become unplugged	Check that the plug is securely in wall receptacle
	Fuse may have blown	Replace the fuse
	Voltage is too high or too low	Have a Certified Electrician test the voltage
	Batteries in remote control may have been exhausted	Replace the batteries
	The time you have set with timer is incorrect	Wait or cancel timer setting
The unit does not cool or heat (if applicable) the room very well while air flows out from the air conditioner	Inappropriate temperature setting	Set the temperature correctly. For details please refer to "Using Remote Control" section
	Air filter is blocked	Clean the air filter
	Doors or windows are open	Close the doors and windows
	Air inlet or outlet of indoor or outdoor unit has been blocked	Clear the obstructions away first, then restart the unit
	The compressor's 3 minutes protection has been activated	Wait for 3 minutes

## Normal function of the air conditioner

The following symptoms do not indicate air conditioner malfunction.

Air is not blown out immediately in heat mode	The unit is designed to not blow cold air on HEAT mode, when the indoor heat exchanger is in one of the following three situations and the set temperature has not been reached: a) When heating has just started. b) Defrosting. c) Low temperature heating. The indoor or outdoor fan stop running when defrosting (cooling and heating models only).
The unit turns to Fan mode from cool or heat mode automatically	When the room temperature reaches the temperature setting on air conditioner, the compressor will stop automatically, and the air conditioner turns to FAN only mode. The compressor will start again when the room temperature rises on COOL mode or falls on HEAT mode (for cooling & heating models only) to the set point.

# Troubleshooting

Please check the following prior to contacting your Electrolux Service Centre.

Problem	Cause
The unit does not operate	The unit does not operate if it is turned on immediately after it is turned off. This is to protect the unit compressor. Please wait for about 3 minutes before turning the unit on again.
Odours are emitted	Some odours may be emitted from the indoor unit. This is the result of room smells (such as furniture, tobacco, etc) which have been taken into the unit. Consult your authorised service centre for cleaning if the odours persist.
“Water flowing” noise	The swishing noise like water flowing is the refrigerant flowing inside the unit.
Mist is emitted in COOL mode	During cooling operation, a thin mist may be seen emitted from the indoor unit due to high room temperature and humidity. After a period of time, the mist will disappear as the room temperature and humidity decrease.
Cracking noise	This is the sound of friction caused by expansion and/or contraction of panel or other parts due to the change of temperature.
The unit cannot be started up	<ul style="list-style-type: none"> <li>• Is the power cut off?</li> <li>• Is the power plug loose?</li> <li>• Is the circuit protection device tripped off?</li> <li>• Is voltage higher or lower? (tested by professionals)</li> <li>• Is the TIMER correctly used?</li> <li>• Are the batteries exhausted?</li> </ul>
Cooling/Heating effect is poor	<ul style="list-style-type: none"> <li>• Is the temperature setting appropriate?</li> <li>• Is the air inlet/outlet blocked?</li> <li>• Is the filter dirty?</li> <li>• Is the door or window open?</li> <li>• Is low fan speed set?</li> <li>• Are there heat sources in the room?</li> </ul>
Water leakage of indoor unit	<ul style="list-style-type: none"> <li>• The humidity is high.</li> <li>• Condensing water overflows.</li> <li>• Drain hose is loose or obstructed.</li> </ul>
Water leakage of outdoor unit	<ul style="list-style-type: none"> <li>• During cooling operation, water condenses around the pipes and connection joints.</li> <li>• During defrosting operation, thawed water flows out.</li> <li>• During heating operation, water on the heat exchanger drips out.</li> </ul>
Noise from indoor unit	<ul style="list-style-type: none"> <li>• The noise emitted when the fan or compressor relay is switched on or off.</li> <li>• When the defrosting operation is started or stopped, there is a sound of refrigerant flowing in the reverse direction.</li> </ul>
Indoor unit cannot blow air	<ul style="list-style-type: none"> <li>• In HEAT mode, when the temperature of indoor heat exchanger is very low, airflow is stopped in order to prevent cold air (within 2 minutes).</li> <li>• In HEAT mode, when the outdoor temperature is low or humidity is high, frost will be formed on the outdoor and the indoor heat exchanger. The unit will defrost automatically and indoor unit will stop blowing air for 2-3 minutes.</li> <li>• During defrosting operation, water or vapour may be emitted.</li> <li>• In DEHUMIDIFY mode, the indoor fan will stop blowing air for 3 to 12 minutes in order to avoid condensing water being vapourised again.</li> </ul>
Moisture on the air outlet	If the unit operates at high humidity for a long time, moisture may be generated on the air outlet grill and then drip off.
H1 code: defrosting	This is normal. The unit is in defrosting operation and heating will recommence soon.





**This document sets out the terms and conditions of the product warranties for Electrolux Appliances. It is an important document. Please keep it with your proof of purchase documents in a safe place for future reference should you require service for your Appliance.**

1. In this warranty:
    - (a) 'acceptable quality' as referred to in clause 10 of this warranty has the same meaning referred to in the ACL;
    - (b) 'ACL' means Schedule 2 to the Competition and Consumer Act 2010;
    - (c) 'Appliance' means any Electrolux product purchased by you and accompanied by this document;
    - (d) 'ASC' means Electrolux authorised service centres;
    - (e) 'Electrolux' means Electrolux Home Products Pty Ltd of 163 O'Riordan Street, Mascot NSW 2020, ABN 51 004 762 341 in respect of Appliances purchased in Australia and Electrolux (NZ) Limited (collectively 'Electrolux') of 3-5 Niall Burgess Road, Mount Wellington, in respect of Appliances purchased in New Zealand;
    - (f) 'major failure' as referred to in clause 10 of this warranty has the same meaning referred to in the ACL and includes a situation when an Appliance cannot be repaired or it is uneconomic for Electrolux, at its discretion, to repair an Appliance during the Warranty Period;
    - (g) 'Warranty Period' means the Appliance is warranted against manufacturing defects in Australia and New Zealand for the period of 60 months, subject to this warranty and to the customer meeting the Warranty Condition.
    - (h) 'Warranty Condition' means:
      - (i) evidence by the customer that the Appliance was installed by a licensed air conditioner installer in Australia and in accordance with Electrolux installation guidelines as set out in the installation manual;
      - (ii) the Appliance rating is correct for the size and thermal characteristics of the room;
      - (iii) the Appliance has been regularly maintained in accordance with Electrolux guidelines set out in the user manual;
      - (iv) the Appliance is designed for providing human comfort and should be used under ambient conditions as set out in the product specifications and general air quality conditions.
    - (i) 'you' means the purchaser of the Appliance not having purchased the Appliance for re-sale, and 'your' has a corresponding meaning.
  2. This warranty only applies to Appliances purchased and used in Australia or New Zealand in normal domestic applications and is in addition to (and does not exclude, restrict, or modify in any way) any non-excludable statutory warranties in Australia or New Zealand.
  3. During the Warranty Period Electrolux or its ASC will, at no extra charge if your Appliance is readily accessible for service, without special equipment and subject to these terms and conditions, repair or replace any parts which it considers to be defective. Electrolux or its ASC may use remanufactured parts to repair your Appliance. You agree that any replaced Appliances or parts become the property of Electrolux. This warranty does not apply to light globes, batteries, filters or similar perishable parts.
  4. Parts and Appliances not supplied by Electrolux are not covered by this warranty.
  5. To the extent permitted by law, you will bear the cost of transportation, travel and delivery of the Appliance to and from Electrolux or its ASC. If you reside outside of the service area, you will bear the cost of:
    - (a) travel of an authorised representative;
    - (b) transportation and delivery of the Appliance to and from Electrolux or its ASC.
6. Proof of purchase is required before you can make a claim under this warranty.
  7. You may not make a claim under this warranty unless the defect claimed is due to faulty or defective parts or workmanship. Electrolux is not liable in the following situations (which are not exhaustive):
    - (a) the Appliance is damaged by:
      - (i) accident
      - (ii) misuse or abuse, including failure to properly maintain or service
      - (iii) normal wear and tear
      - (iv) power surges, electrical storm damage or incorrect power supply
      - (v) incomplete or improper installation
      - (vi) incorrect, improper or inappropriate operation
      - (vii) insect or vermin infestation
      - (viii) failure to comply with any additional instructions supplied with the Appliance;
    - (b) the Appliance is modified without authority from Electrolux in writing;
    - (c) the Appliance's serial number or warranty seal has been removed or defaced;
    - (d) the Appliance was serviced or repaired by anyone other than Electrolux, an authorised repairer or ASC.
  8. This warranty, the contract to which it relates and the relationship between you and Electrolux are governed by the law applicable where the Appliance was purchased. Where the Appliance was purchased in New Zealand for commercial purposes the Consumer Guarantee Act does not apply.
  9. To the extent permitted by law and subject to your non-excludable statutory rights and warranties, Electrolux excludes all warranties and liabilities (other than as contained in this document) including liability for any loss or damage whether direct or indirect arising from your purchase, use or non use of the Appliance.
  10. For Appliances and services provided by Electrolux in Australia, the Appliances come with a guarantee by Electrolux that cannot be excluded under the ACL. You are entitled to a replacement or refund for a major failure and for compensation for any other reasonably foreseeable loss or damage. You are also entitled to have the Appliance repaired or replaced if the Appliance fails to be of acceptable quality and the failure does not amount to a major failure. The benefits to you given by this warranty are in addition to your other rights and remedies under a law in relation to the Appliances or services to which the warranty relates.
  11. At all times during the Warranty Period, Electrolux shall, at its discretion, determine whether repair, replacement or refund will apply if an Appliance has a valid warranty claim applicable to it.
  12. For Appliances and services provided by Electrolux in New Zealand, the Appliances come with a guarantee by Electrolux pursuant to the provisions of the Consumer Guarantees Act, the Sale of Goods Act and the Fair Trading Act.
  13. To enquire about claiming under this warranty, please follow these steps:
    - (a) carefully check the operating instructions, user manual and the terms of this warranty;
    - (b) have the model and serial number of the Appliance available;
    - (c) have the proof of purchase (e.g. an invoice) available;
    - (d) telephone the numbers shown below.
  14. You accept that if you make a warranty claim, Electrolux and its ASC may exchange information in relation to you to enable Electrolux to meet its obligations under this warranty.

### Important Notice

Before calling for service, please ensure that the steps listed in clause 13 above have been followed.

<p><b>FOR SERVICE</b> or to find the address of your nearest state service centre in Australia <b>PLEASE CALL 13 13 49</b> For the cost of a local call (Australia only)</p>	<p><b>SERVICE AUSTRALIA</b>  <b>Electrolux</b> ELECTROLUX HOME PRODUCTS www.electrolux.com.au</p>	<p><b>FOR SPARE PARTS</b> or to find the address of your nearest state spare parts centre in Australia <b>PLEASE CALL 13 13 50</b> For the cost of a local call (Australia only)</p>
<p><b>FOR SERVICE</b> or to find the address of your nearest authorised service centre in New Zealand <b>FREE CALL 0800 10 66 10</b> (New Zealand only)</p>	<p><b>SERVICE NEW ZEALAND</b>  <b>Electrolux</b> ELECTROLUX (NZ) Limited www.electrolux.co.nz</p>	<p><b>FOR SPARE PARTS</b> or to find the address of your nearest state spare parts centre in New Zealand <b>FREE CALL 0800 10 66 20</b> (New Zealand only)</p>



**If you'd like further information about Kelvinator appliances, please visit your retailer, phone or email our Customer Care team or visit our website.**

telephone: 1300 363 640

fax: 1800 350 067

email: [customercare@electrolux.com.au](mailto:customercare@electrolux.com.au)

web: [www.kelvinator.com.au](http://www.kelvinator.com.au)

**Kelvinator. We are part of the Electrolux family.  
Share more of our thinking at [www.electrolux.com.au](http://www.electrolux.com.au)**