



OWNER'S MANUAL

FRIDGE & FREEZER



Before beginning installation, read these instructions carefully. This will simplify installation and ensure that the product is installed correctly and safely. Leave these instructions near the product after installation for future reference.

ENGLISH

GT-2S / GT-2W / GT-2PL / GT-1S



MFL71905205
Rev.01_051723

www.lg.com

Copyright © 2023 LG Electronics Inc. All Rights Reserved.

TABLE OF CONTENTS

This manual may contain images or content that may be different from the model you purchased.
This manual is subject to revision by the manufacturer.

SAFETY INSTRUCTIONS

READ ALL INSTRUCTIONS BEFORE USE..... 3
WARNING 3
CAUTION 9

INSTALLATION

Before Installation 11
Levelling the Appliance 11
Turning on the Power..... 12
Moving the Appliance for Relocation 12

OPERATION

Before Use 13
Product Features..... 16
Control Panel 18
Water Dispenser..... 19
Icemaker 20
Automatic Icemaker 21
Fridge Drawer 23
Door Basket 23
Shelf 23

SMART FUNCTIONS

LG ThinQ Application..... 24
Smart Diagnosis 24

MAINTENANCE

Cleaning 25

TROUBLESHOOTING

Before Calling for Service..... 26

SAFETY INSTRUCTIONS

READ ALL INSTRUCTIONS BEFORE USE

The following safety guidelines are intended to prevent unforeseen risks or damage from unsafe or incorrect operation of the appliance. The guidelines are separated into 'WARNING' and 'CAUTION' as described below.

Safety Messages



This symbol is displayed to indicate matters and operations that can cause risk. Read the part with this symbol carefully and follow the instructions in order to avoid risk.



WARNING

This indicates that the failure to follow the instructions can cause serious injury or death.



CAUTION

This indicates that the failure to follow the instructions can cause the minor injury or damage to the product.

WARNING



WARNING

- To reduce the risk of explosion, fire, death, electric shock, injury or scalding to persons when using this product, follow basic precautions, including the following:

Technical Safety

- This appliance is not intended for use by persons (including children) with reduced physical, sensory or mental capabilities, or lack of experience and knowledge, unless they have been given supervision or instruction concerning use of the appliance by a person

responsible for their safety. Children should be supervised to ensure that they do not play with the appliance.

- If the power cord is damaged or the hole of the outlet socket is loose, do not use the power cord and contact an authorized service centre.
- Do not damage the refrigerant circuit.
- Do not use mechanical devices or other means to accelerate the defrosting process.
- Keep ventilation openings, in the appliance enclosure or in the built-in structure, clear of obstruction.
- Do not use electrical appliances inside the food storage compartments of the appliance, unless they are of the type recommended by the manufacturer.
- The refrigerant and insulation blowing gas used in the appliance require special disposal procedures. Consult with service agent or a similarly qualified person before disposing of them.
- This appliance is intended to be used in household and similar applications only. It should not be used for commercial, or catering purposes, or in any mobile application such as a caravan or boat.
- Do not store explosive substances such as aerosol cans with a flammable propellant in this appliance.



This symbol alerts you to flammable materials that can ignite and cause a fire if you do not take care.

- This appliance contains a small amount of isobutane refrigerant (R600a), but it is also combustible. When transporting and installing the appliance, care should be taken to ensure that no parts of the refrigerating circuit are damaged.
- When positioning the appliance, ensure the supply cord is not trapped or damaged.
- Do not locate multiple portable outlet-sockets or portable power supplies at the rear of the appliance.
- Disconnect the power cord before cleaning the appliance interior or exterior.

- Securely plug the power plug in the outlet socket after completely removing any moisture and dust.
- Never unplug the appliance from the power supply by pulling on the power cable. Always grip the power plug firmly and pull straight out from the outlet socket.
- Do not spray water or inflammable substances (toothpaste, alcohol, thinner, benzene, flammable liquid, abrasive, etc.) over the interior or exterior of the appliance to clean it.
- Do not clean the appliance with brushes, cloths or sponges with rough surfaces or which are made of metallic material.
- Only qualified service personnel from LG Electronics service centre should disassemble or repair the appliance.
- Do not use a hair drier to dry the inside of the appliance or place a candle inside to remove the odours.
- Do not tilt the appliance to pull or push it when transporting.
- Make sure not to get a body part such as a hand or foot stuck while moving the appliance.
- Consult with a service agent or a similarly qualified person about the recovery of refrigerant and recycling of components on disposal of the refrigerating appliance.

Risk of Fire and Flammable Materials

- If a leak is detected, avoid any naked flames or potential sources of ignition and air the room in which the appliance is standing for several minutes. In order to avoid the creation of a flammable gas air mixture if a leak in the refrigerating circuit occurs, the size of the room in which the appliance is used should correspond to the amount of refrigerant used. The room must be 1 m² in size for every 8 g of R600a refrigerant inside the appliance.
- Refrigerant leaking out of the pipes could ignite or cause an explosion.
- The amount of refrigerant in your particular appliance is shown on the identification plate inside the appliance.

Installation

- This appliance should only be transported by two or more people holding the appliance securely.
- Install the appliance on a firm and level floor.
- Do not install the appliance in a damp and dusty place. Do not install or store the appliance in any outdoor area, or any area that is subject to weathering conditions such as direct sunlight, wind, rain, or temperatures below freezing.
- Do not place the appliance in direct sunlight or expose it to the heat from heating appliances such as stoves or heaters.
- Be careful not to expose the rear of the appliance when installing.
- Install the appliance in a place where it is easy to unplug the power plug of the appliance.
- In the event that a door needs to be removed to pass the unit through a doorway, be careful not to let the appliance door fall during assembly or disassembly.
- Be careful not to pinch, crush, or damage the power cable during assembly or disassembly of the appliance door.
- Be careful not to point the power plug up or let the appliance lean against the power plug.
- Do not connect a plug adapter or other accessories to the power plug.
- Do not modify or extend the power cable.
- Ensure that the outlet socket is properly grounded, and that the earth pin on the power cord is not damaged or removed from the power plug. For more details on grounding, inquire at an LG Electronics customer information centre.
- This appliance is equipped with a power cord having an equipment-grounding conductor and a grounding power plug. The power plug must be plugged into an appropriate outlet socket that is installed and grounded in accordance with all local codes and ordinances.
- Never start up an appliance showing any signs of damage. If in doubt, consult your dealer.

- Dispose of all packaging materials (such as plastic bags and styrofoam) away from children. The packaging materials can cause suffocation.
- Do not plug the appliance into multiple outlet sockets, power boards, or an extension power cable.
- Do not use an extension cord or double adapter.

Operation

- Do not use the appliance for any purpose (storage of medical or experimental materials or temperature strict medicines) other than any domestic household food storage use.
- If water penetrates electrical parts of the appliance, disconnect power plug and contact an LG Electronics customer information centre.
- Unplug the power plug during a severe lightening or thunderstorm or when not in use for a long period of time.
- Do not touch the power plug or the appliance controls with wet hands.
- Do not bend the power cable excessively or place a heavy object on it.
- Immediately unplug the power plug and contact an LG Electronics customer information centre if you detect a strange sound, odour, or smoke coming from the appliance.
- Do not place hands or metallic objects inside the area emitting the cold air, covers or heat releasing grille on the back.
- Do not apply excessive force or impact to the back cover of the appliance.
- Be careful of nearby children when you open or close the appliance door. The door may bump the child and cause injury.
- Avoid the danger of children getting trapped inside the appliance. A child trapped inside the appliance can cause suffocation.
- Do not put animals, such as pets into the appliance.
- Do not place heavy or fragile objects, containers filled with liquid, combustible substances, flammable objects (such as candles, lamps,

etc.), or heating devices (such as stoves, heaters, etc.) on the appliance.

- Do not place any electronic appliance (such as heater and mobile phone) inside the appliance.
- If there is a gas leakage (isobutane, propane, natural gas, etc.), do not touch the appliance or power plug and ventilate the area immediately. This appliance uses a refrigerant gas (isobutane, R600a). Although it uses a small amount of the gas, it is still combustible gas. Gas leakage during appliance transport, installation or operation can cause fire, explosion or injury if sparks are caused.
- Do not use or store flammable or combustible substances (ether, benzene, alcohol, chemical, LPG, combustible spray, insecticide, air freshener, cosmetics, etc.) near the appliance.
- This appliance incorporates an earth connection for functional purposes.
- Connect to potable water supply only (only for models with dispenser function needing plumbed connection).
 - If connected to a water supply, connect to a potable water supply only.
- Fill with potable water only.
 - If using an icemaker or dispenser water tank, make sure to fill it with potable water only.

Disposal

- When discarding the appliance, remove the door gasket while leaving the shelves and baskets in place and keep children away from the appliance.

CAUTION

CAUTION

- To reduce the risk of minor injury to persons, malfunction, or damage to the product or property when using this product, follow basic precautions, including the following:

ENGLISH

Operation

- This appliance must only be used with a town power supply. Solar inverters and generator power supplies could cause disruption to performance and potentially damage the electronics.
- Do not touch frozen food or the metal parts in the freezer compartment with wet or damp hands. It may cause frostbite.
- Do not place glass containers, bottles or cans (especially those containing carbonated drinks) in the freezer compartment, shelves or ice bin that will be exposed to temperatures below freezing.
- The tempered glass on the front side of the appliance door or the shelves can be damaged by an impact. If it is broken, do not touch it with hands.
- Do not hang from the appliance doors, door baskets, storage compartments or shelves, or climb up into the appliance.
- Do not store an excessive amount of water bottles or containers in the door baskets.
- Do not open or close the appliance door with excessive force.
- If the hinge of the appliance door is damaged or operates improperly, stop using the appliance and contact an authorized service centre.
- Prevent animals from nibbling on the power cable or water hose.
- Never eat frozen foods immediately after they have been taken out of the freezer compartment.
- Make sure not to get a hand or foot stuck upon opening or closing the appliance door or door in door.

Maintenance

- This appliance is equipped with maintenance-free LED interior light. Do not remove cover or LED lamp in any attempt to repair or change it. Contact an LG Electronics customer information centre.
- Do not clean glass shelves or covers with warm water when they are cold. They may shatter if exposed to sudden temperature changes.
- Do not insert the shelves upside down. The shelves may fall.
- If ice forms in the freezer compartment, please contact LG Electronics customer service. Do not use sharp-edged objects to remove any frost or ice build-up. Do not use sprays, electric heating devices such as fan heaters, hair dryers, steam cleaners or other heat sources for defrosting. Plastic parts could deform.
- Dispose of the ice inside the ice bin in the freezer compartment during an extended power outage.

INSTALLATION

Before Installation

Dimensions and Clearances

Too small of a distance from adjacent items may result in the degradation of freezing capability and increased electricity costs. Allow over 50 mm of clearance between the back of the appliance and the wall when installing the appliance.

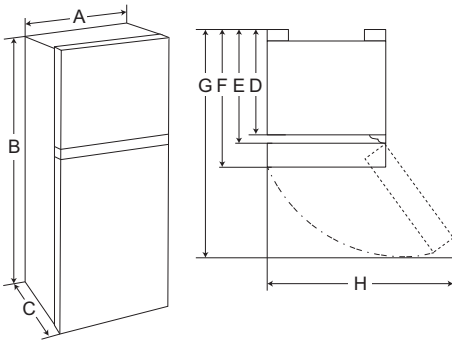

| - | Type (mm) | | |
|---|-----------|------|------|
| - | a | b | c |
| A | 555 | 555 | 555 |
| B | 1680 | 1573 | 1445 |
| C | 637 | 637 | 637 |
| D | 551 | 551 | 551 |
| E | 604 | 604 | 604 |
| F | 637 | 637 | 637 |
| G | 999 | 999 | 999 |
| H | 953 | 953 | 953 |

NOTE

- You can determine what type of appliance it is by looking at the label inside the appliance.

Ambient Temperature

- The appliance is designed to operate within a limited range of ambient temperatures, depending on the climate zone.
- The internal temperatures could be affected by the location of the appliance, the ambient temperature, the frequency of door opening and so on.
- The climate class can be found on the rating label.

| Climate Class | Ambient Temperature Range °C |
|-------------------------|--------------------------------------|
| SN (Extended Temperate) | +10 - +32 |
| N (Temperate) | +16 - +32 |
| ST (Subtropical) | +16 - +38 / +18 - +38** |
| T (Tropical) | +10 - +43* / +16 - +43 / +18 - +43** |

* Australia, India, Kenya

** Argentina

NOTE

- The appliances rated from SN to T are intended to be used at an ambient temperature between 10 °C and 43 °C.

Levelling the Appliance

Adjusting the Levelling Leg

If the appliance seems unsteady, or the doors do not close easily, adjust the appliance's tilt using the instructions below.

12 INSTALLATION

- 1 Turn the levelling leg clockwise to raise that side of the appliance or counterclockwise to lower it.

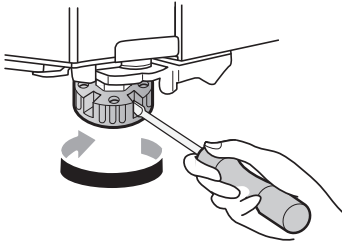

- 2 Open the doors and check to make sure that they close easily.

NOTE

- Leveling the doors may not be possible when the floor is not leveled, or is of weak or poor construction.
 - The refrigerator is heavy and should be installed on a rigid and solid surface.
 - Some timber flooring may cause levelling difficulties if it flexes excessively.
-

Turning on the Power

Connecting the Appliance

To turn on the appliance, connect the power plug into the outlet socket. Do not double up with other appliances on the same outlet.

NOTE

- After connecting the power supply cord (or plug) to the outlet, wait 3 or 4 hours before you put food into the appliance. If you add food before the appliance has cooled completely, your food may spoil.
 - To turn off the appliance, disconnect the power plug from the outlet socket.
-

Moving the Appliance for Relocation

Moving the Appliance

- 1 Remove all food from inside the appliance.
- 2 Pull the power plug out, insert and fix it into the power plug hook at the rear or on top of the appliance.
- 3 Tape parts such as shelves and the door handle to prevent from falling off while moving the appliance.
- 4 Move the appliance with more than two people carefully. When transporting the appliance over a long distance, keep the appliance upright.
- 5 After installing the appliance, connect the power plug into a mains outlet socket and switch it on.

OPERATION

Before Use

Notes for Operation

- Before placing food in the appliance, clean the inside and outside of the appliance with warm water and a mild washing-up liquid to remove manufacturing residues.
- Users should keep in mind that frost can form if the door is not closed completely or if the humidity is high during the summer.
- Ensure there is sufficient space between food stored on the shelf or door basket to allow the door to close completely.
- Opening the door for long periods can cause a significant increase of the temperature in the compartments of the appliance.
- If the refrigerating appliance is left empty for long periods, switch off, defrost, clean, dry, and leave the door open to prevent mould developing within the appliance.
- Note that a temperature rise after defrosting has a permissible range in the appliance specifications. If you wish to minimise the impact on the food storage due to a temperature rise, seal or wrap the stored food in several layers.

Door Open Alarm

This feature is only available on some models.

The alarm sounds 3 times in 30 second intervals if the door is left open or not completely closed for 1 minute.

NOTE

- Contact the LG Electronics customer information centre if the alarm sound continues even after closing all doors.

Failure Detection

The appliance can automatically detect problems during the operation.

NOTE

- If a problem is detected, the appliance may not operate and an error code is displayed even when any button is pressed.
- If an error code is indicated on the display, do not turn off the power. Immediately contact the LG Electronics customer information centre and report the error code. If you turn off the power, the repair technician from the our information centre may have difficulty finding the problem.

Suggestion for Energy Saving

- For the most efficient use of energy, keep all inner parts (e.g. door bins, drawers and shelves) on their original location.
- Ensure there is sufficient space between stored foods. This allows cold air to be circulated evenly and lowers electricity bills.
- Store hot food only after it has cooled in order to prevent dew or frost.
- When storing food in the freezer compartment, set the freezer temperature lower than the temperature indicated on the food.
- Do not set the temperature of the appliance lower than needed.
- Do not put food near the temperature sensor of the fridge compartment. Keep a distance of at least 3 cm from the sensor.

Storing Foods Effectively

- Food may freeze or spoil if stored at the wrong temperature. Set the refrigerator to the correct temperature for the food being stored.
- Store frozen food or refrigerated food inside sealed containers.
- Check the expiration date and label (storage instructions) before storing food in the appliance.

14 OPERATION

- Do not store food for a long period of time if it spoils easily at a low temperature.
- Do not place unfrozen food in direct contact with food that is already frozen. Do not store excessive amounts of fresh food.
 - Refer to the maximum freezing capacity of your appliance on the rating label inside the fridge compartment.
 - If you want to freeze food over several days, only store up to about 2/3 of the maximum freezing capacity.
- Freeze food in portion-sized quantities for faster freezing, easier thawing and processing.
- Place the refrigerated food or frozen food in each fridge or freezer compartment immediately after purchasing.
- Store raw meat and fish in suitable containers in the refrigerator, so that it is not in contact with or drip onto other food.
- Refrigerated foods and other food items can be stored on top of the vegetable drawer.
- Avoid refreezing any food which has been completely thawed. Freezing any food which has been completely thawed again will lower its taste and nutrition.
 - Only take out the amount of food that you need. Consume thawed food quickly. It can only be refrozen after being cooked.
- Cool hot food before storing. If too much hot food is placed inside, the internal temperature of the appliance can increase and negatively affect other foods stored in the appliance.
- Do not overfill the appliance. Cold air can not circulate properly if the appliance is overfilled.
- If you set an excessively low temperature for food, it may become frozen. Do not set a temperature lower than the required temperature for the food to be stored correctly.
- If there are chill compartments in the appliance, do not store vegetables and fruits with higher moisture content in the chill compartments as they may freeze due to the lower temperature.
- Always follow the food manufacturer's instructions on the permissible storage duration of frozen food. Do not exceed the recommended storage time of food.
 - Mark the storage date, permissible storage duration, and the food name on the packaging to prevent it from exceeding the storage time limit.
- In the event of a blackout, call the electricity company and ask how long it is going to last.
 - You should avoid door openings while the power is off.
 - When the power supply gets back to normal, check the condition of the food.
 - If the power outage lasts longer, especially during the summer months, please follow these guidelines:
 - Do not place additional food into the appliance during the power outage.
 - If the power outage is announced and is expected to last for more than 10 hours, prepare some ice and put it in a container on the top shelf of the fridge.
 - Due to the temperature increase in the appliance during a power outage or other malfunction, the shelf life of the food will be reduced and its quality will decrease. If necessary, process thawed food and freeze it again in the cooked state.

Maximum Freezing Capacity

- For maximum freezing capacity, set the freezer temperature to the coldest temperature setting.
- **Express Freeze** function will allow the freezer to reach its maximum freezing capacity. This generally takes up to 21 hours and automatically switches off.
- **Express Freeze** must be switched on when fresh products are placed in the freezer compartment.
- To freeze food items quickly, store the food in the left side of lower compartment. Food items will freeze most quickly in the zone.
- To get better air circulation, insert all inner parts like baskets, drawers, and shelves.

NOTE

- The max freezing capacity of your appliance is stated on the rating label inside the fridge compartment.
-

Freezing the Maximum Amount of Food

If large quantities of food are to be stored, the icemaker should be taken out of the appliance and the food should be stacked directly on the freezer shelves in the freezer compartment.

NOTE

- Insert the icemaker in the right position.
-

Product Features

The appearance or components of the appliance may differ from model to model.

Interior

*1 This feature is only available on some models.

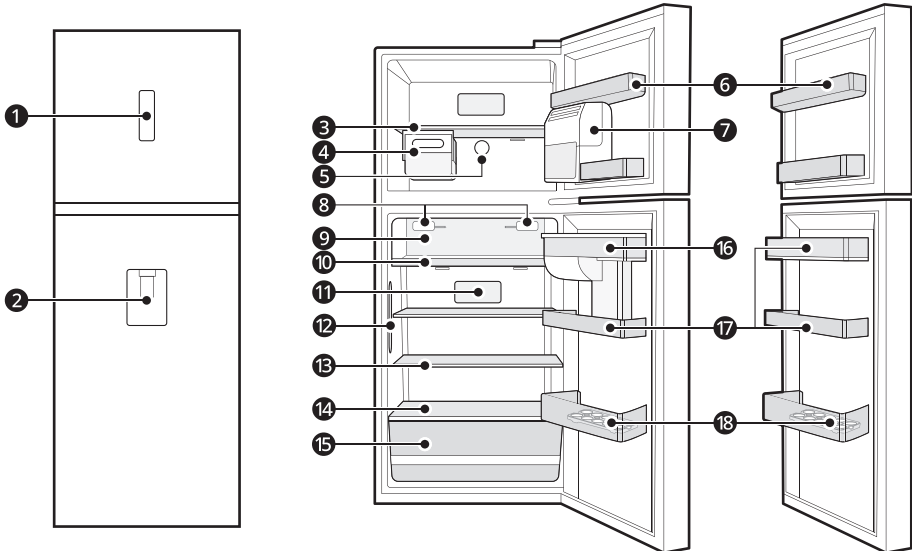

1 Control panel*1

Sets the fridge temperature.

2 Water Dispenser*1

3 Freezer Shelf

Stores frozen foods such as meat, fish, and icecream.

4 Moving Icemaker*1

This is where ice is manually produced and stored.

- You can slide the icemaker along the shelf from side to side to any desired position.

5 Freezer Temperature Controller*1

This controller regulates the air flow to the freezer compartment by setting it to a suitable balance.

6 Freezer Door Basket

Stores small packages of frozen food. Do not store ice cream or food which will be stored for a long period of time.

7 Automatic Icemaker*1

This is where ice is automatically produced and stored.

8 Air filter

Reduces odours inside the fridge compartment.

NOTE

- Do not disassemble the air filter. If you want to replace it, please contact the LG Electronics customer information centre.

9 Fresh Room^{*1}

This is where food items are stored at a colder temperature than the regular fridge area.

10 Pull Out Tray**11 Fridge Temperature Control Panel^{*1}**

Sets the fridge temperature.

12 Door Cooling^{*1}

Cold air comes out to keep the fridge door basket cool.

13 Fridge Shelf

Stores refrigerated foods and fresh foods.

- Stores the foods with higher moisture content at the front of the shelf.
- The shelf height can be adjusted by inserting the shelf in another groove of different height.
- The actual number of shelves will differ from model to model.

14 Bottom Shelf

Stores refrigerated foods and fresh foods.

⚠ CAUTION

- Do not store any items at the front of the bottom shelf. The items may fall and cause an injury or appliance damage.

15 Fridge Drawer

Stores fruits and vegetables.

16 Water Tank^{*1}

This is where water is stored to supply the dispenser.

17 Fridge Door Basket

Stores small packages of refrigerated foods, drinks and sauce containers.

- The actual number of baskets will differ from model to model.

18 Movable Egg Tray^{*1}

This is where eggs are stored.

- You can move it to and use it at a desired position as needed. However, do not use it as the ice bin or place it on the shelf on top of the fridge or the vegetables drawer.

Control Panel

The actual control panel may differ from model to model.

Control Panel and Functions

Control Panel 1: Inside the Fridge

Turn the dial to select a desired temperature between **Cold** and **Coldest**.

Turn the controller to select the **Express Freeze** and activate the function for 21 hours.

- This function automatically shuts off after 21 hours.
- After this function shuts off, turn the controller to select a desired temperature.

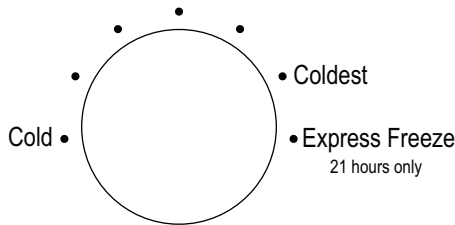

NOTE

- After the **Express Freeze** function shuts off, the controller still points to the **Express Freeze**, but the temperature setting is automatically changed to the mid-level temperature setting.
-

Control Panel 2: Inside the Freezer

Turn the dial to select a desired temperature between **Min** and **Max**.

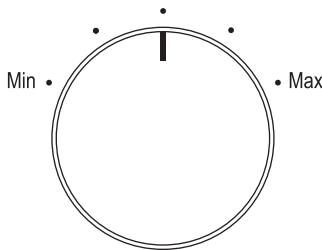

Setting the Freezer Temperature Level (1-5)

The temperature can be adjusted from level 1 to level 5. Level 3 is recommended.

- You can lower the temperature by turning the controller to the right and raise the temperature by turning the controller to the left.

- Setting the controller at level 4-5 will maintain a low temperature in the freezer. When the quick

freezing is finished (level 5), set the controller to the recommended level.

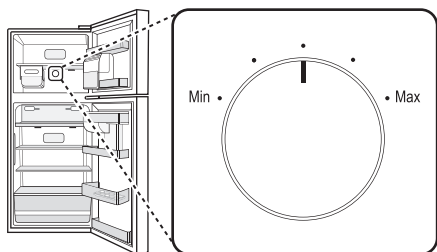

NOTE

- For optimal food preservation, increasing or decreasing one level from the default temperature is recommended.
- Wait until 2 or 3 hours have passed after connecting the appliance to the outlet before storing food in the appliance.
- The internal temperatures could be affected by the location of the appliance, the ambient temperature, the frequency of door opening and so on.

Water Dispenser

This feature is only available on some models.

Using the Dispenser

You can dispense water by pressing the lever.

- Press the paddle ① of the water dispenser to get cold water.

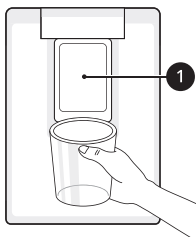

CAUTION

- Keep children away from the dispenser to prevent children playing with or damaging the controls.

NOTE

- If the cup rim is small, water may splash out of the glass or miss it completely.

Cleaning the Dispenser

- Wipe the entire area with a damp cloth. The dispenser may become wet easily due to spilled water.
- Wipe the dispenser outlet frequently with a clean cloth as it may get dirty easily.

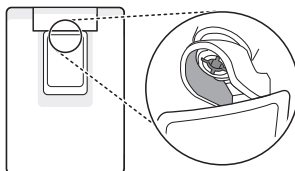

NOTE

- Lint from a cloth may adhere to the outlet.

Filling the Water Tank

The water tank holds the water which is to be dispensed.

- 1 Open the cap on the top of the water tank.

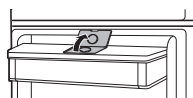

20 OPERATION

- 2 Fill the water tank with potable water and close the cap.

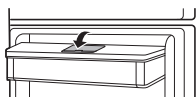

⚠ WARNING

- Fill with potable water only. Do not fill the water tank with beverages or hot water.
- Children should not be allowed near the water tank.

⚠ CAUTION

- Do not apply excessive force or impact when removing or assembling the water dispenser tank.

NOTE

- The water tank should be washed before filling it with potable water.
- If water does not come out, fill the water tank with potable water.

Cleaning the Water Tank

- 1 Remove the water tank cover.



- 2 Empty the water tank.

- 3 Hold the water tank with both hands and pull it up.

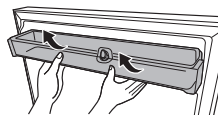

- 4 Remove the water valve ① in the water tank by turning it clockwise.

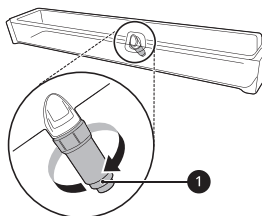

- 5 Clean the water tank and the water valve in running water. Wipe the inside and outside of the water tank and the fridge door with a clean cloth.

- 6 Mount the water tank in the reverse order of the removal process.

NOTE

- Clean water tanks if they have not been used for 48 hours.

Icemaker

This feature is only available on some models.

Using the Moving Icemaker

This is where ice is manually produced and stored.

- 1 Pull out the ice tray from the Icemaker.

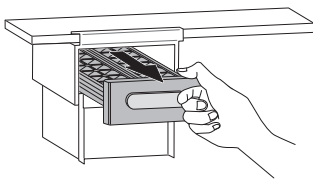

- 2 Fill the ice tray with water up to the marked water line.

- 3 Hold and push the ice tray back to its original position.

- 4 Hold the lever of the ice tray and turn it clockwise to release the ice cubes.

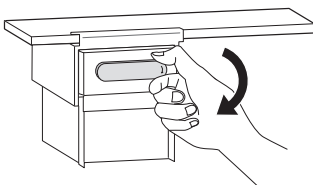

- 5 Hold the handle of the ice basket and pull out it.

⚠ WARNING

- Fill with potable water only.

⚠ CAUTION

- Be careful not to spill water when pushing the ice tray.
- Be careful not to twist the ice tray with force as it can be broken.
- If you open and close the freezer door frequently, it may take longer for water to be frozen.
- Do not fill the ice basket with water.

NOTE

- You can remove the ice maker to create more space inside the freezer compartment if you do not use it.
- If the ice tray is overfilled, the ice cubes may stick together and be difficult to remove.
- Ice can be removed more easily by pouring water on the ice tray.

Using the Ice Tray

This is where ice is manually produced.

Fill the ice tray with water up to the marked water line.

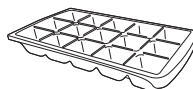

⚠ WARNING

- Fill with potable water only.

⚠ CAUTION

- Be careful not to twist the ice tray with force as it can be broken.
- If you open and close the freezer door frequently, it may take longer for water to be frozen.

NOTE

- If the ice tray is overfilled, the ice cubes may stick together and be difficult to remove.
- Ice can be removed more easily by pouring water on the ice tray.

Automatic Icemaker

This feature is only available on some models.

Before Using the In-Door Icemaker

⚠ CAUTION

- The first ice and water dispensed may include particles or odour from the water supply line or the water tank.
- If discolored ice is dispensed, check the water tank and the water supply for a possible source. If the problem continues, contact the LG Electronics customer information centre. Do not use the ice or water until the problem is corrected.
- Do not touch the automatic icemaker with your hand or a tool.
- Do not remove the cover of the automatic icemaker.
- Dispose of the ice inside the ice bin if you go on vacation or if an extended power outage occurs.

NOTE

- The icemaker produces ice normally when approximately 48 hours have passed after the appliance is initially installed.
- If the ice bin is completely filled with ice, ice production will stop.
- Sound of ice dropping into the ice bin is normal.
- If ice cubes are stored in the ice bin for a long period of time, they may clump together and may not be separated easily. In such a case, empty the ice bin and allow fresh ice to be made.

In-Door Icemaker

The automatic icemaker can automatically make 6 cubes at a time, 30-50 cubes within a 24-hour period if conditions are favorable. This amount may vary according to the environment (ambient temperature around the appliance, frequency of

the door being opened, amount of food stored in the appliance, etc.).

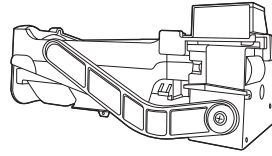

Turning the Automatic Icemaker On or Off

To turn the automatic icemaker On/Off, press the **Ice On/Off** button on the control panel.

⚠ CAUTION

- Do not keep the power turned on to the icemaker if the water line is not connected. Doing so can damage the icemaker.

Normal Sounds You May Hear

The icemaker water valve will buzz as the icemaker fills with water. If the **Ice On/Off** button is set to **On**, it will buzz even if it has not yet been hooked up to water. To stop the buzzing, press the **Ice On/Off** button to **Off** position.

⚠ CAUTION

- Do not keep the power turned on to the icemaker if the water tank is empty. Doing so can damage the icemaker.

NOTE

- You will hear the sound of ice dropping into the bin and water running in the pipes as the icemaker refills.

Preparing for Vacation

If the ambient temperature will drop below freezing, have a qualified technician drain the water supply system to prevent serious property

damage due to flooding caused by ruptured water lines or connections.

Set the **Ice On/Off** button to Off and shut off the water supply to the appliance.

⚠ CAUTION

- The ice bin should be emptied any time the **Ice On/Off** button is turned Off.

Fridge Drawer

Removing and Refitting the Fresh Vegetable Drawer

- 1 Remove the contents of the drawer. Hold the handle of the vegetable drawer and gently pull it out outward until the drawer stops completely.
- 2 Lift the vegetable drawer up and remove it by pulling it out.

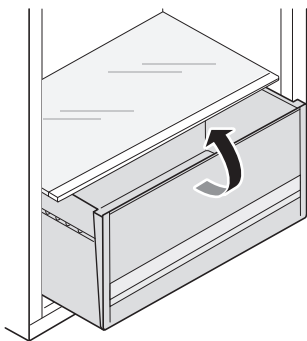

- 3 Mount the vegetable drawer in the reverse order of the removal process.

⚠ CAUTION

- Remove all food from inside the appliance, otherwise injuries can be caused by the weight of stored foods.

Door Basket

Removing/Refitting the Door Basket

- 1 Hold both edges of the basket and remove it by lifting it upward.

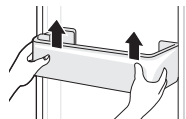

- 2 Refit the door basket in the reverse order of the removal process.

Shelf

Removing/Refitting the Shelf

- 1 Hold the both side of the shelf. Lift the shelf up and remove it by pulling it out.

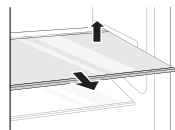

- 2 Refit the shelf by sliding it inward until the shelf snaps into the frame.

SMART FUNCTIONS

LG ThinQ Application

The **LG ThinQ** application allows you to communicate with the appliance using a smartphone.

LG ThinQ Application Feature

*1 This feature is only available on some models.

Smart Diagnosis*1

If you experience a problem while using the appliance, this smart diagnosis feature will help you diagnose the problem.

NOTE

- The application is subject to change for product improvement purposes without notice to users.

Installing the LG ThinQ Application

Search for the **LG ThinQ** application from the Google Play Store or Apple App Store on a smartphone. Follow instructions to download and install the application.

Smart Diagnosis

This feature is only available on some models.

Use this feature to help you diagnose and solve problems with your appliance.

NOTE

- For reasons not attributable to LGE's negligence, the service may not operate due to external factors such as, but not limited to, Wi-Fi unavailability, Wi-Fi disconnection, local app store policy, or app unavailability.
- The feature may be subject to change without prior notice and may have a different form depending on where you are located.

Using Audible Diagnosis to Diagnose Issues

Follow the instructions below to use the audible diagnosis method.

- Launch the **LG ThinQ** application and select the **Smart Diagnosis** feature in the menu. Follow the instructions for audible diagnosis provided in the **LG ThinQ** application.

1 Open the fridge door.

2 Close and open the fridge door 5 times within 8 seconds.

NOTE

- If you do not close and open the door 5 times within 8 seconds, the time will be reset. Then you have to close and open the door 5 times again.

3 If the buzzer sounds 4 times, open the freezer door and hold the phone near the speaker hole.

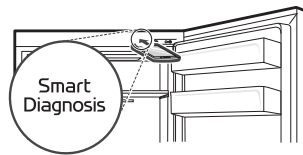

4 After the data transfer is complete, the diagnosis will be displayed in the application.

NOTE

- For best results, do not move the phone while the tones are being transmitted.

MAINTENANCE

Cleaning

General Cleaning Tips

- When cleaning the inside or outside of the appliance, do not wipe it with a rough brush, toothpaste, or abrasive pads. Do not use any chemical cleaners that contain or are blended with solvents or flammable substances or caustic based detergents. These include but are not limited to:
 - Flammable substances: alcohol (ethanol, methanol, isopropyl alcohol, isobutyl alcohol, etc.), thinner, bleach, benzene, flammable liquid, abrasive, etc.
 - This may cause discolouration or damage to the appliance's internal parts and wall lining.
- After cleaning, check if the power cable is damaged.

Cleaning the Exterior

- The outside air vents and rear lower cover should be cleaned periodically to remove dust build up. Failure to do so could cause the appliance to lose its cooling ability and cause the compressor to overheat and malfunction resulting in food loss.
- When cleaning the side vents and rear lower cover by vacuuming, then the power cord must be unplugged from the outlet to avoid any static discharge that can damage the electronics or cause an electric shock. Regular cleaning of the rear and side ventilation covers is also necessary to maintain reliable and economical operation of the unit.
- Failure to keep the air vents on the exterior of the appliance clean can also cause overheating, appliance damage or property damage if the defrosted water cannot evaporate from the rear drain pan.
- For the appliance exterior, use a clean sponge or soft cloth and a mild detergent in warm water. Do not use abrasive or harsh cleaners. Dry thoroughly with a soft dedicated cloth. Do not use contaminated cloths when cleaning the

stainless steel doors. Always use a dedicated cloth and wipe in the same direction as the grain. This helps reduce surface staining and tarnishing.

Cleaning the Interior

- Before removing a shelf or drawer from inside the appliance, remove all stored foods from the shelf or drawer to prevent injury or damage to the appliance. Otherwise, injury may occur due to the weight of stored foods.
- Detach the shelves and drawers and clean them with water and a mild detergent, and then dry them sufficiently, before replacing them.
- Regularly wipe the door gaskets with a wet soft towel.
- Door basket spills and stains should be cleaned as they can compromise storage ability of the basket and could even be damaged.
- Never clean the shelves or containers in the dishwasher. The parts may become deformed due to the heat.
- The automatic defrosting system in the appliance ensures that the compartment remains free of ice buildup under normal operating conditions. Users do not need to defrost it manually.

TROUBLESHOOTING

Before Calling for Service

Cooling

| Symptoms | Possible Cause & Solution |
|--|---|
| There is no refrigeration or freezing. | Is there a power interruption? <ul style="list-style-type: none"> Check the power of other appliances. |
| | Appliance is unplugged. <ul style="list-style-type: none"> Plug the power plug in the outlet properly. |
| | A fuse in your home may be blown or the circuit breaker tripped. Or the appliance is connected to a GFCI (Ground Fault Circuit Interrupter) outlet, and the outlet's circuit breaker has tripped. <ul style="list-style-type: none"> Check the main electrical box and replace the fuse or reset the circuit breaker. Do not increase fuse capacity. If the problem is a circuit overload, have it corrected by a qualified electrician. Reset the circuit breaker on the GFCI. If the problem persists, contact an electrician. |
| There is poor refrigeration or freezing. | Is the fridge or freezer temperature set to its warmest setting? <ul style="list-style-type: none"> Set the fridge or freezer temperature to a colder setting. |
| | Is the appliance in direct sunlight, or is it near a heat generating object such as cooking oven or heater? <ul style="list-style-type: none"> Check the installation area and reinstall it away from heat generating objects. |
| | Did you store hot food without cooling it first? <ul style="list-style-type: none"> Cool the hot food first before putting it in the fridge or freezer compartment. |
| | Did you put in too much food? <ul style="list-style-type: none"> Maintain an appropriate space between food. |
| | Are the appliance doors completely closed? <ul style="list-style-type: none"> Completely close the door and make sure that stored food is not obstructing in the door. |
| | Is there enough space around the appliance? <ul style="list-style-type: none"> Adjust the installation position to make enough space around the appliance. |
| The appliance contains a bad smell. | Is the fridge or freezer temperature set to 'Warm'? <ul style="list-style-type: none"> Set the fridge or freezer temperature to a colder setting. |

| Symptoms | Possible Cause & Solution |
|-------------------------------------|---|
| The appliance contains a bad smell. | Did you put in food with a strong smell? <ul style="list-style-type: none"> Store foods with strong smells in a sealed containers. |
| | Vegetables or fruit may have spoiled in the drawer? <ul style="list-style-type: none"> Throw away rotten vegetables and clean the vegetable drawer. Do not store vegetables too long in the vegetable drawer. |

Condensation & Frost

| Symptoms | Possible Cause & Solution |
|--|---|
| There is condensation inside the appliance or on the bottom of the vegetable drawer cover. | Did you store hot food without cooling it first? <ul style="list-style-type: none"> Cool the hot food first before putting it inside the fridge or freezer. |
| | Did you leave the appliance door open? <ul style="list-style-type: none"> Although the condensation will disappear soon after you close the appliance door, you can wipe it with a dry cloth. |
| | Do you open and close the appliance door too frequently? <ul style="list-style-type: none"> Condensation can form due to the temperature difference from the outside. Wipe out the dampness with a dry cloth. |
| | Did you put warm or moist food inside without sealing it in a container? <ul style="list-style-type: none"> Store food in a covered or sealed container. |

Water

| Symptoms | Possible Cause & Solution |
|--------------------------|--|
| Water does not come out. | The water dispenser tank may be empty. (Non plumbed models only) <ul style="list-style-type: none"> Fill the water dispenser tank. |

Parts & Features

| Symptoms | Possible Cause & Solution |
|--|--|
| The inside lamp in the appliance does not turn on. | Lamp failure <ul style="list-style-type: none"> Close the door and re-open. If the lamp does not turn on, please contact the LG Electronics customer information centre. Do not attempt removal of the lamp. |

Noises

| Symptoms | Possible Cause & Solution |
|--|---|
| The appliance is noisy and generates abnormal sounds. | Is the appliance installed on a weak floor or improperly levelled? <ul style="list-style-type: none"><li data-bbox="325 252 768 276">• Install the appliance on a solid and flat area. |
| | Does the rear of the appliance touch the wall? <ul style="list-style-type: none"><li data-bbox="325 331 1005 384">• Adjust the installation position to allow enough clearance around the appliance. |
| | Are objects scattered behind the appliance? <ul style="list-style-type: none"><li data-bbox="325 435 891 459">• Remove the scattered objects from behind the appliance. |
| | Is there an object on top of the appliance? <ul style="list-style-type: none"><li data-bbox="325 515 757 539">• Remove the object on top of the appliance. |

Memo

Memo

Memo

